

# User's Guide

## WX3401-B0/WX3100-T0

Dual-Band Wireless Extender

### Default Login Details

|                |                      |
|----------------|----------------------|
| LAN IP Address | http://192.168.1.2   |
| Login          | admin                |
| Password       | See the device label |

Version 5.17–5.50 Ed 1, 11/2020

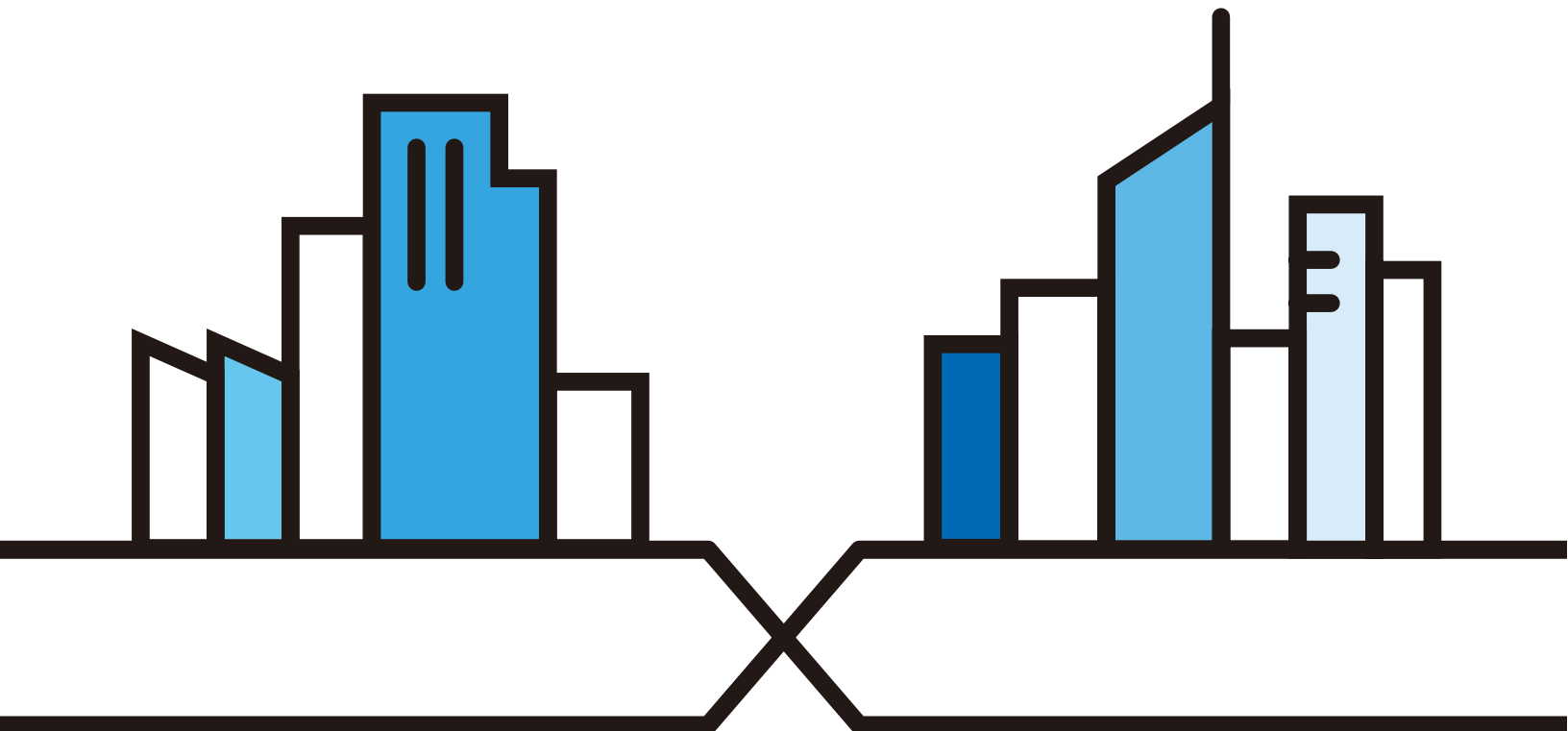

---

**IMPORTANT!**

**READ CAREFULLY BEFORE USE.**

**KEEP THIS GUIDE FOR FUTURE REFERENCE.**

Screenshots and graphics in this book may differ slightly from what you see due to differences in your product firmware or your computer operating system. Every effort has been made to ensure that the information in this manual is accurate.

### **Related Documentation**

- Quick Start Guide

The Quick Start Guide shows how to connect the WX Device.

- More Information

Go to **support.zyxel.com** to find other information on the WX Device.



# Document Conventions

## Warnings and Notes

These are how warnings and notes are shown in this guide.

**Warnings tell you about things that could harm you or your device.**









Note: Notes tell you other important information (for example, other things you may need to configure or helpful tips) or recommendations.

## Syntax Conventions

- The device in this user's guide may be referred to as the "WX Device" in this guide.
- Product labels, screen names, field labels and field choices are all in **bold** font.
- A right angle bracket ( > ) within a screen name denotes a mouse click. For example, **Network Setting > Wireless > MAC Authentication** means you first click **Network Setting** in the navigation panel, then the **Wireless** sub menu and finally the **MAC Authentication** tab to get to that screen.

## Icons Used in Figures

Figures in this user guide may use the following generic icons. The WX Device icon is not an exact representation of your device.

|  |   |   |
|--|---|---|
| WX Device<br> | Generic Router<br> | Laptop Computer<br> |
| Switch<br>    | Firewall<br>       | Server<br>          |
| Internet<br>  | User<br>           | Smartphone<br>      |

# Contents Overview

|   |            |
|---|------------|
| <b>User's Guide</b> .....                   | <b>10</b>  |
| Introduction .....                          | 11         |
| Hardware .....                              | 21         |
| The Web Configurator .....                  | 30         |
| <b>Technical Reference</b> .....            | <b>37</b>  |
| App Tutorials .....                         | 38         |
| Web Tutorials .....                         | 71         |
| Connection Status .....                     | 83         |
| Wireless .....                              | 92         |
| Home Networking .....                       | 124        |
| Log .....                                   | 127        |
| Multicast Status .....                      | 130        |
| WLAN Station Status .....                   | 132        |
| System .....                                | 134        |
| User Account .....                          | 135        |
| Remote Management .....                     | 138        |
| Time Settings .....                         | 140        |
| Firmware Upgrade .....                      | 143        |
| Backup/Restore .....                        | 146        |
| Diagnostic .....                            | 150        |
| <b>Troubleshooting and Appendices</b> ..... | <b>152</b> |
| Troubleshooting .....                       | 153        |

# Table of Contents

|   |           |
|---|-----------|
| <b>Document Conventions</b> .....         | <b>3</b>  |
| <b>Contents Overview</b> .....            | <b>4</b>  |
| <b>Table of Contents</b> .....            | <b>5</b>  |
| <br>                                      |           |
| <b>Part I: User's Guide</b> .....         | <b>10</b> |
| <br>                                      |           |
| <b>Chapter 1</b>                          |           |
| <b>Introduction</b> .....                 | <b>11</b> |
| 1.1 Overview .....                        | 11        |
| 1.1.1 WX Device .....                     | 11        |
| 1.1.2 How to set up the WX Device .....   | 12        |
| 1.2 MPro Mesh .....                       | 13        |
| 1.2.1 AP Steering and Band Steering ..... | 13        |
| 1.2.2 Network Controller .....            | 14        |
| 1.3 Dual-Band WiFi .....                  | 16        |
| 1.4 Daisy Chain .....                     | 16        |
| 1.5 MU-MIMO Technology .....              | 18        |
| 1.5.1 2X2:2 MU-MIMO .....                 | 18        |
| 1.5.2 4X4:4 MU-MIMO .....                 | 18        |
| 1.6 2.4/5 GHz MU-MIMO .....               | 19        |
| 1.7 Multicast (for WX3401-B0 only) .....  | 19        |
| <br>                                      |           |
| <b>Chapter 2</b>                          |           |
| <b>Hardware</b> .....                     | <b>21</b> |
| 2.1 Front Panel and LEDs .....            | 21        |
| 2.2 Rear Panel .....                      | 22        |
| 2.3 LEDs (Lights) .....                   | 23        |
| 2.4 Wall Mounting .....                   | 25        |
| 2.4.1 The WX3401-B0 Wall-Mounting .....   | 25        |
| 2.4.2 The WX3100-T0 Wall-Mounting .....   | 26        |
| 2.5 WPS Button .....                      | 28        |
| 2.5.1 Using the WPS Button .....          | 28        |
| 2.6 RESET Button .....                    | 29        |
| 2.6.1 Using the RESET Button .....        | 29        |
| <br>                                      |           |
| <b>Chapter 3</b>                          |           |
| <b>The Web Configurator</b> .....         | <b>30</b> |

3.1 Overview ..... 30

3.2 Accessing the Web Configurator ..... 30

    3.2.1 When the WX Device is connected to a modem/router ..... 30

    3.2.2 When the WX Device is not connected to a router/modem: ..... 31

3.3 Web Configurator Layout ..... 33

    3.3.1 Navigation Panel ..... 33

**Part II: Technical Reference..... 37**

**Chapter 4  
App Tutorials.....38**

4.1 Overview ..... 38

4.2 What You Can Do ..... 38

4.3 Network Setup ..... 38

    4.3.1 Setting up the WX Device with a Zyxel MPro Mesh Router ..... 38

    4.3.2 Setting up the WX Device with a Non-MPro Mesh Router ..... 43

4.4 Network Management with the MPro Mesh App ..... 50

    4.4.1 Managing the Controller ..... 50

    4.4.2 Viewing the Controller Information ..... 51

    4.4.3 Adding Devices to Your Mesh Network ..... 54

    4.4.4 Adding Devices to Your Mesh Network ..... 60

4.5 Devices Screen ..... 62

    4.5.1 Viewing Device Information ..... 63

4.6 WiFi Settings Screen ..... 64

    4.6.1 Editing WiFi Settings ..... 66

4.7 Guest WiFi Settings Screen ..... 67

    4.7.1 Editing Guest WiFi Settings ..... 68

4.8 Account Screen ..... 70

**Chapter 5  
Web Tutorials .....71**

5.1 Overview ..... 71

5.2 WiFi Network Setup ..... 71

    5.2.1 Setting Up a WiFi Network ..... 71

    5.2.2 Setting Up a WiFi Network Using WPS ..... 73

    5.2.3 Setting Up a WiFi Network Without WPS ..... 74

    5.2.4 Setting Up WiFi Network Groups ..... 74

    5.2.5 Connecting to the Zyxel Device's WiFi Network (Windows 10) ..... 78

5.3 Device Maintenance ..... 80

    5.3.1 Upgrading the Firmware ..... 80

    5.3.2 Backing up the Device Configuration ..... 81

|  |            |
|--|------------|
| 5.3.3 Restoring the Device Configuration ..... | 82         |
| <b>Chapter 6</b>                               |            |
| <b>Connection Status.....</b>                  | <b>83</b>  |
| 6.1 Overview .....                             | 83         |
| 6.1.1 Layout Icon .....                        | 84         |
| 6.1.2 Connectivity .....                       | 84         |
| 6.1.3 System Info .....                        | 85         |
| 6.2 WiFi Settings .....                        | 87         |
| 6.3 Guest WiFi Settings .....                  | 88         |
| 6.4 LAN Settings .....                         | 90         |
| <b>Chapter 7</b>                               |            |
| <b>Wireless .....</b>                          | <b>92</b>  |
| 7.1 Wireless Overview .....                    | 92         |
| 7.1.1 What You Can Do in this Chapter .....    | 92         |
| 7.1.2 What You Need to Know .....              | 92         |
| 7.2 Wireless General Settings .....            | 93         |
| 7.2.1 No Security .....                        | 96         |
| 7.2.2 More Secure (Recommended) .....          | 96         |
| 7.3 Guest/More AP .....                        | 98         |
| 7.3.1 Edit Guest/More AP Settings .....        | 98         |
| 7.4 MAC Authentication .....                   | 100        |
| 7.4.1 Add/Edit MAC Addresses .....             | 102        |
| 7.5 WPS Settings .....                         | 102        |
| 7.6 WMM Settings .....                         | 104        |
| 7.7 Others Settings .....                      | 105        |
| 7.8 Channel Status Settings .....              | 107        |
| 7.9 Operating Modes Settings .....             | 108        |
| 7.10 AP List Screen .....                      | 110        |
| 7.11 Technical Reference .....                 | 111        |
| 7.11.1 Wireless Network Overview .....         | 111        |
| 7.11.2 Additional Wireless Terms .....         | 113        |
| 7.11.3 Wireless Security Overview .....        | 113        |
| 7.11.4 Signal Problems .....                   | 115        |
| 7.11.5 BSS .....                               | 115        |
| 7.11.6 MBSSID .....                            | 116        |
| 7.11.7 Preamble Type .....                     | 116        |
| 7.11.8 WiFi Protected Setup (WPS) .....        | 117        |
| <b>Chapter 8</b>                               |            |
| <b>Home Networking.....</b>                    | <b>124</b> |
| 8.1 Home Networking Overview .....             | 124        |

|  |            |
|--|------------|
| 8.1.1 What You Can Do in this Chapter .....  | 124        |
| 8.1.2 What You Need To Know .....            | 124        |
| 8.1.3 Before You Begin .....                 | 124        |
| 8.2 Home Networking Screen .....             | 125        |
| <b>Chapter 9</b>                             |            |
| <b>Log .....</b>                             | <b>127</b> |
| 9.1 Log Overview .....                       | 127        |
| 9.1.1 What You Can Do in this Chapter .....  | 127        |
| 9.1.2 What You Need To Know .....            | 127        |
| 9.2 System Log Settings .....                | 128        |
| <b>Chapter 10</b>                            |            |
| <b>Multicast Status .....</b>                | <b>130</b> |
| 10.1 Multicast Status Overview .....         | 130        |
| 10.2 IGMP Status .....                       | 130        |
| 10.3 MLD Status .....                        | 130        |
| <b>Chapter 11</b>                            |            |
| <b>WLAN Station Status .....</b>             | <b>132</b> |
| 11.1 WLAN Station Status Overview .....      | 132        |
| <b>Chapter 12</b>                            |            |
| <b>System.....</b>                           | <b>134</b> |
| 12.1 System Overview .....                   | 134        |
| 12.2 System Settings .....                   | 134        |
| <b>Chapter 13</b>                            |            |
| <b>User Account.....</b>                     | <b>135</b> |
| 13.1 User Account Overview .....             | 135        |
| 13.2 User Account Settings .....             | 135        |
| 13.2.1 User Account Add/Edit .....           | 136        |
| <b>Chapter 14</b>                            |            |
| <b>Remote Management.....</b>                | <b>138</b> |
| 14.1 Remote Management Overview .....        | 138        |
| 14.1.1 What You Can Do in this Chapter ..... | 138        |
| 14.2 MGMT Services .....                     | 138        |
| <b>Chapter 15</b>                            |            |
| <b>Time Settings.....</b>                    | <b>140</b> |
| 15.1 Time Settings Overview .....            | 140        |
| 15.2 Time .....                              | 140        |



|  |            |
|--|------------|
| <b>Chapter 16</b>  |            |
| <b>Firmware Upgrade .....</b>                              | <b>143</b> |
| 16.1 Firmware Upgrade Overview .....                       | 143        |
| 16.2 Firmware Upgrade Settings .....                       | 143        |
| <b>Chapter 17</b>  |            |
| <b>Backup/Restore .....</b>                                | <b>146</b> |
| 17.1 Backup/Restore Overview .....                         | 146        |
| 17.2 Backup/Restore Settings .....                         | 146        |
| 17.3 Reboot .....  | 148        |
| <b>Chapter 18</b>  |            |
| <b>Diagnostic.....</b>                                     | <b>150</b> |
| 18.1 Diagnostic Overview .....                             | 150        |
| 18.1.1 What You Can Do in this Chapter .....               | 150        |
| 18.2 What You Need to Know .....                           | 150        |
| 18.3 Ping & TraceRoute .....                               | 151        |
| <br>   |            |
| <b>Part III: Troubleshooting and Appendices.....</b>       | <b>152</b> |
| <br>   |            |
| <b>Chapter 19</b>  |            |
| <b>Troubleshooting.....</b>                                | <b>153</b> |
| 19.1 Power and Hardware Problems .....                     | 153        |
| 19.2 Device Access Problems .....                          | 154        |
| 19.3 Internet Problems .....                               | 155        |
| 19.4 WiFi Problems .....                                   | 156        |
| 19.5 Resetting the WX Device to Its Factory Defaults ..... | 156        |
| 19.6 MPro Mesh App Problems .....                          | 157        |
| 19.7 Daisy Chain Problems .....                            | 157        |
| Appendix A Customer Support .....                          | 159        |
| Appendix B IPv6.....                                       | 165        |
| Appendix C Services.....                                   | 173        |
| Appendix D Legal Information .....                         | 177        |
| <b>Index .....</b>   | <b>184</b> |

---

# PART I

## User's Guide

---

# CHAPTER 1

# Introduction

## 1.1 Overview

The WX Device refers to the following models.

- WX3401-B0
- WX3100-T0

Use any of the following methods to manage the WX Device.

- Web Configurator. Use the Web Configurator for management of the WX Device using a supported web browser.
- MPro Mesh App. Download the MPro Mesh app from Google Play or Apple Store to manage the WX Device using a phone or tablet.

### 1.1.1 WX Device

A WX Device is a dual-band wireless extender that can extend WiFi coverage from a router/modem with Internet access. The WX Device supports MPro Mesh that lets a controller manage your WiFi network.

The following table describes the features of the WX Device by model.

Table 1 WX Device Comparison Table

|                           | WX3401-B0   | WX3100-T0   |
|---------------------------|---|---|
| 2.4 G WLAN                | Y   | Y   |
| 5 G WLAN                  | Y   | Y   |
| MU-MIMO                   | 2.4 GHz: 2*2<br>5 GHz: 4*4                        | 2.4 GHz: 2*2<br>5 GHz: 2*2                        |
| Antenna                   | Internal  | Internal  |
| Gigabit Ethernet LAN Port | 2   | 2   |
| Mesh                      | Y   | Y   |
| Wall Mount                | Y   | Y   |
| WPS                       | Y   | Y   |
| Multicast                 | Y   | N   |
| Mobile APP                | MPro Mesh app<br>iOS: v 2.1.0<br>Android: v 2.1.0 | MPro Mesh app<br>iOS: v 2.1.0<br>Android: v 2.1.0 |
| Latest Firmware Version   | 5.17  | 5.50  |

## 1.1.2 How to set up the WX Device

The WX Device can function as a Repeater or an Access Point (AP).

Set your WX Device to **Repeater** (RP) mode, if you want to connect an existing WiFi network through another Access Point and also provide network connection to WiFi clients. In this mode, the WX Device can be an access point and a WiFi client at the same time. If the WX Device has a WiFi uplink connection, it is in RP mode.

In the following figure, the WX Device (**A**) is in **Repeater** (RP) mode and is letting a WiFi client connect to the network wirelessly through a router (**B**). This helps you expand WiFi coverage when you already have an access point or wireless router in your network.

**Figure 1** Device Operation Mode Example: Repeater Mode

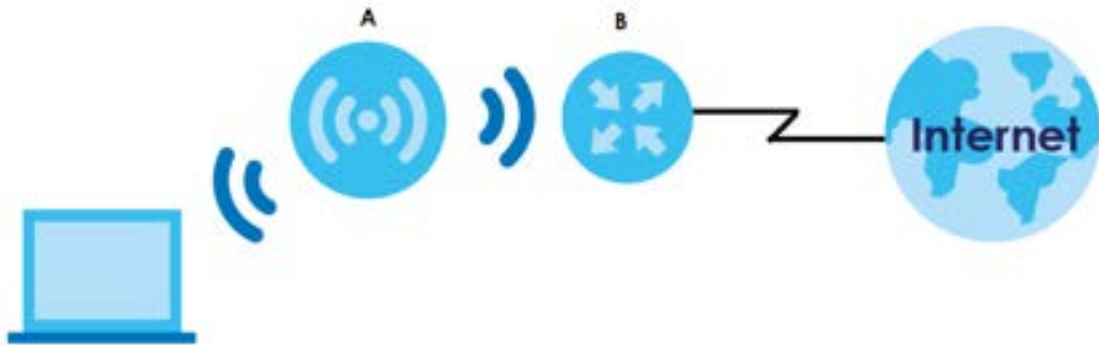

Set your WX Device to **Access Point** (AP) mode if you already have a router in your network and you want to bridge a wired network (LAN) and another LAN or wireless LAN (WLAN) in the same subnet. If the WX Device has a wired uplink connection, it is in AP mode.

In the following figure, the WX Device (**A**) is in **Access Point** (AP) mode, and is bridging a wired network and a wired LAN in the same subnet.

**Figure 2** Device Operation Mode Example: AP Mode

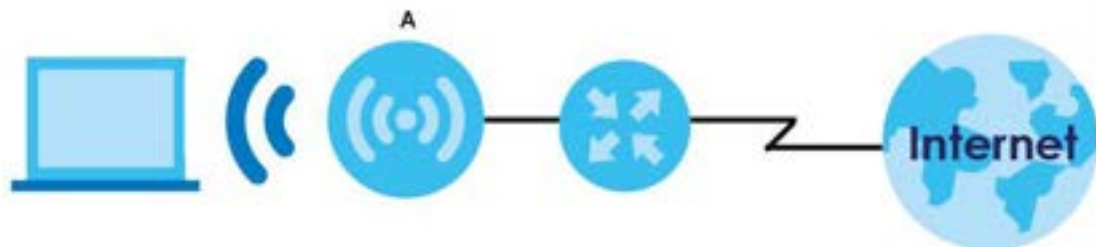

The WX Device can use both 2.4 GHz and 5 GHz networks at the same time. For more information on dual-band WiFi, see [Section 1.3 on page 16](#).

You can add more WX Devices to your network to form a daisy chain. For more information, see [Section 1.4 on page 16](#).

Set up a Mesh network with your WX Device to use band steering, AP steering, auto-configuration and other advanced features for your WiFi network. For more information, see [Section 1.2.1 on page 13](#).

Manage the WX Device and your WiFi network using the MPro Mesh app. You can check your WiFi network status, change passwords or set up a WiFi access with a QR code. For more information, see [Chapter 4 on page 38](#).

## 1.2 MPro Mesh

The WX Device supports MPro Mesh that lets a controller manage your WiFi network. A controller can automatically configure WiFi settings on extenders in the network as well as optimize bandwidth usage. The controller optimizes bandwidth usage by directing WiFi clients to an extender (AP steering) or 2.4GHz / 5GHz band (band steering) that is less busy.

- If the router/modem is an MPro Mesh router/modem, then the router/modem is the controller.
- If the router/modem is not an MPro Mesh router/modem, then the WX Device is the controller.

### 1.2.1 AP Steering and Band Steering

Zyxel MPro Mesh supports AP steering and Band steering.

- AP steering allows WiFi clients to roam seamlessly between Mesh supported devices in your Mesh network by using the same SSID and WiFi password. Also, AP steering helps monitor WiFi clients and drop their connections to optimize the WX Device bandwidth when the clients are idle or have a low signal. When a WiFi client is dropped, it has the opportunity to reconnect to a Mesh AP with a strong signal.

**Figure 3** AP Steering Application

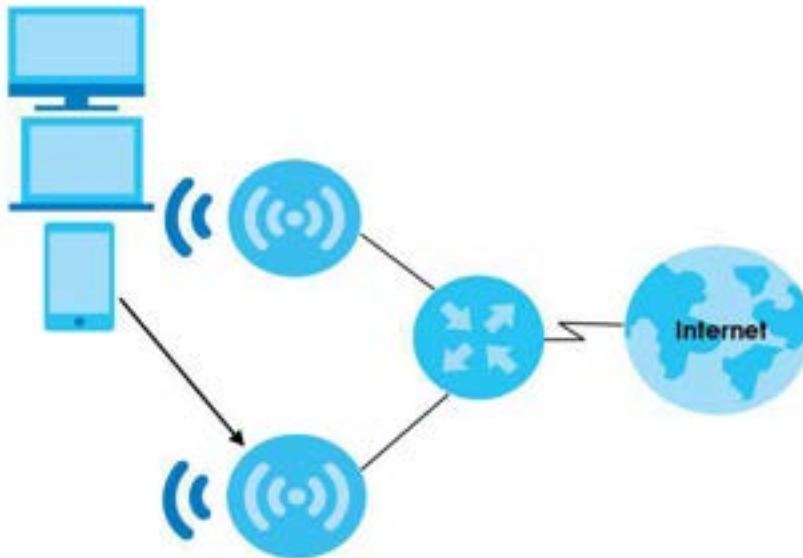

- Band steering allows 2.4 GHz/5 GHz dual-band WiFi clients to move from one band to another. For example, if the 2.4 GHz channel is congested, WiFi clients that support 5 GHz can move to the 5 GHz band.

**Figure 4** Band Steering Application

## 1.2.2 Network Controller

To set up a Mesh network, you need a router or an AP that can function as a controller in order. A controller manages and coordinates WiFi activity in a network.

A controller also manages the SSIDs and passwords on all APs in a network (auto-configuration). For example, if you change the SSID on the controller, the SSID of each AP in the network will also change.

Note: For AP steering and band steering to work, the controller and all the APs in the network need to have the same SSID and password. Therefore, we recommend using the controller to change the SSID and password.

Figure 5 Mesh Application

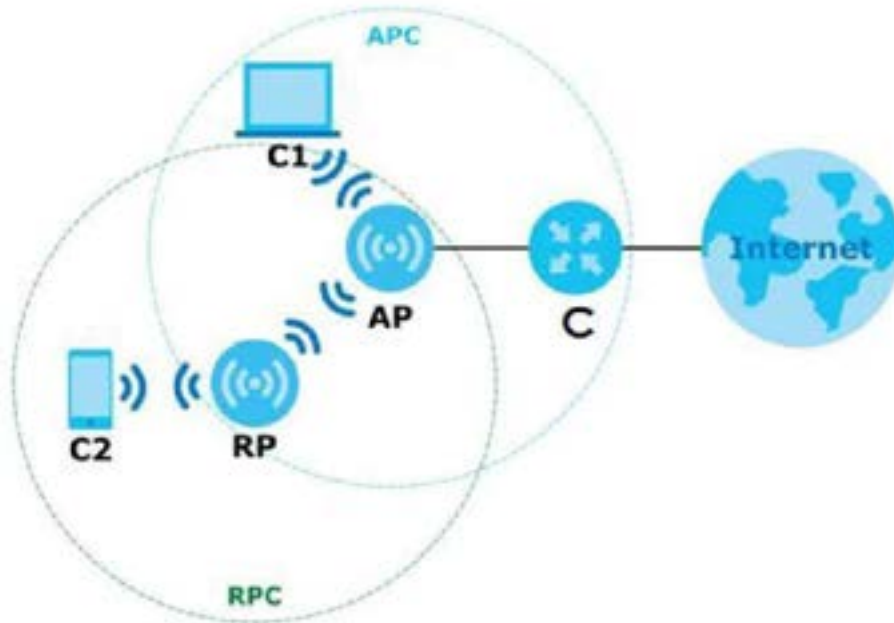

The following table describes the icons used in the figure.

Table 2 Icons used in Mesh Application

| ICON | DESCRIPTION  |
|------|--|
| C    | Router Controller (the DX5301-B0 in Scenario 1, see <a href="#">Section 4.3.1 on page 38</a> ) or AP controller (the first WX Device in Scenario 2, see <a href="#">Section 4.3.2 on page 43</a> ) |
| AP   | Access Point   |
| RP   | Repeater   |
| C1   | Client1  |
| C2   | Client2  |
| APC  | Access Point coverage area   |
| RPC  | Repeater coverage area   |

Note: Your router must have an Internet connection whether it supports MPro Mesh or not.

Note: If your router supports Zyxel MPro Mesh, it will serve as the router controller in a Mesh network with the WX Device.

Note: If your router does not support Zyxel MPro Mesh, your WX Device will automatically become the AP controller.

## 1.3 Dual-Band WiFi

The WX Device is a dual-band device that can use both 2.4 GHz and 5 GHz at the same time. IEEE 802.11a/b/g/n/ac/ax compliant clients can wirelessly connect to the WX Device to access network resources. You could use the 2.4 GHz band for regular Internet surfing and downloading while using the 5 GHz band for time sensitive traffic like high-definition video, music, and gaming.

**Figure 6** Dual-Band Application

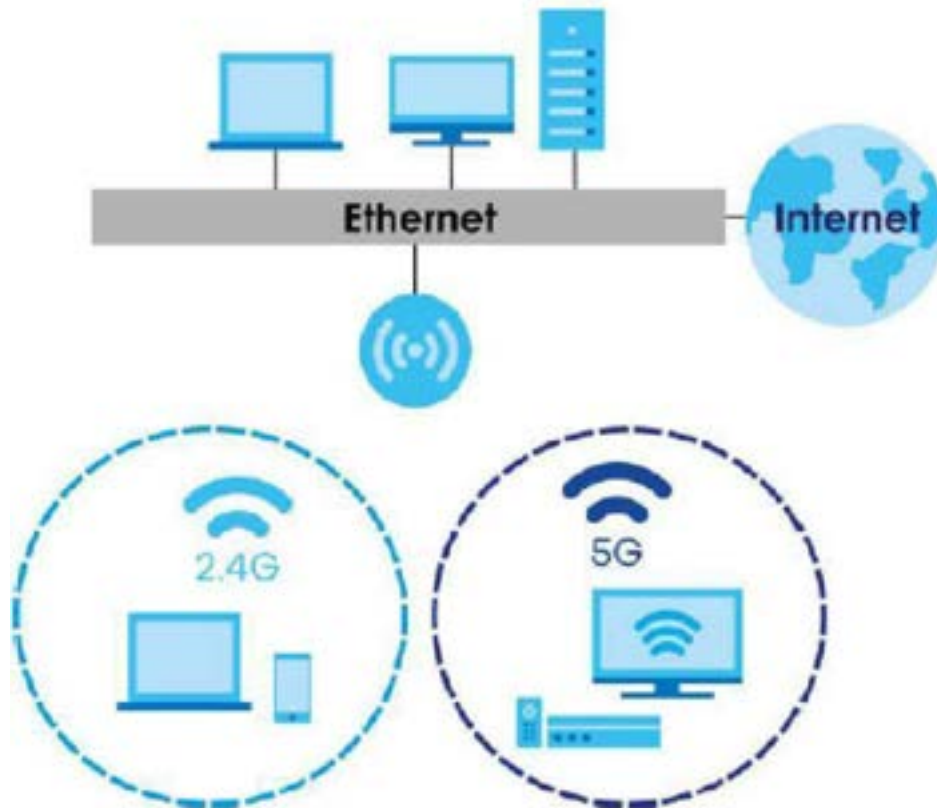

## 1.4 Daisy Chain

You can add more WX Device to your network to form a daisy chain. Daisy chain refers to the connection from the first WX Device to up to three other WX Devices to extend the WiFi connection from the router to the client. The WX Device uplink connection determines the mode: **Access Point (AP)** or **Repeater (RP)**.

- If the WX Device has a wired uplink connection, it is in AP mode.
- If the WX Device has a WiFi uplink connection, it is in RP mode.

Here are some example scenarios for the WX Device's daisy chain connection:



Figure 7 Scenario 1: Three APs

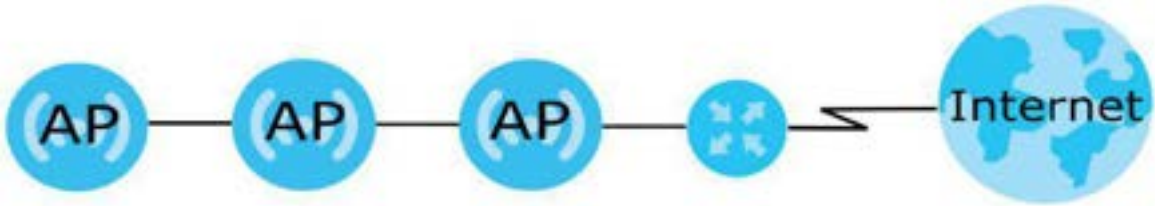

Figure 8 Scenario 2: Two APs and one RP

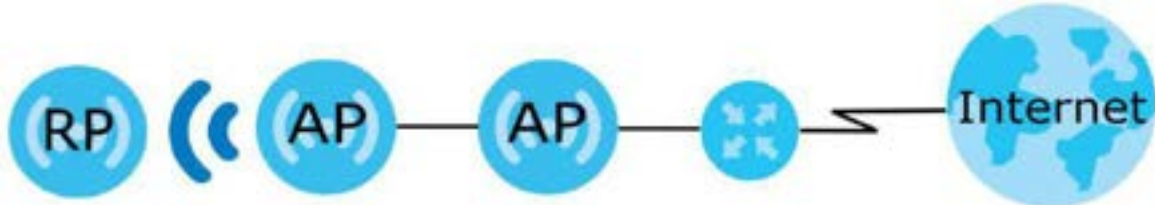

Figure 9 Scenario 3: One AP and two RPs

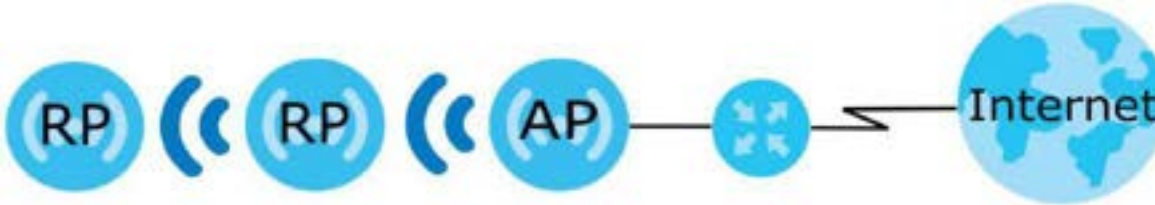

Figure 10 Scenario 4: Two RPs



Note: Set up your network as in Scenarios 1-3 if your router does not support Zyxel MPro Mesh. Scenario 4 is only for routers that support Zyxel MPro Mesh.

Note: We do not recommend connecting more than three WX Devices in your daisy chain network. If you already have two WX Devices in RP mode, we do not recommend adding another WX Device as a repeater.

Note: If one of the WX Devices has a WiFi uplink connection, we do not recommend linking the other WX Devices in your daisy chain network with a wired connection.

Figure 11 Not Recommended Connection Example



## 1.5 MU-MIMO Technology

Multi-User, Multiple-Input, Multiple-Output (MU-MIMO) allows an AP to transmit and receive data to multiple groups of MU-MIMO enabled WiFi clients at the same time, using a technology called RF multipath. MU-MIMO divides its bandwidth evenly among all MIMO-compatible WiFi clients and keeping the WiFi signal constant for them all. Transmit Beamforming technology lets the AP focus its signals directly to WiFi clients to effectively extend WiFi coverage and minimize dead spots. WiFi clients in the same group can also co-ordinate in order to transmit to the AP at the same time. MU-MIMO helps decrease client waiting time and increase network throughput. This will improve WiFi performance with MU-MIMO compatible WiFi clients.

### 1.5.1 2X2:2 MU-MIMO

2X2:2 MU-MIMO WiFi means an AP allows two transceivers and two receivers to communicate concurrently with multiple WiFi clients, dividing up the bandwidth evenly. In **2X2:2**, the first and second number ( $n \times n$ ) show the number of transmit and receive antennas respectively. The third number ( $: n$ ) means the number of data spatial streams, indicating the number of independent data signals that can be sent simultaneously from a single transmit antenna. For example, in **Figure 12**, when two wireless devices are connected to an AP, the AP can communicate with two devices (Client **C1** and **C2**) simultaneously.

**Figure 12** 2X2:2 MU-MIMO



### 1.5.2 4X4:4 MU-MIMO

4X4:4 MU-MIMO WiFi means an AP allows four transceivers and four receivers to communicate concurrently with multiple WiFi clients, dividing up the bandwidth evenly. For example, in **Figure 13**, when four wireless devices are connected to an AP, the AP can communicate with four devices (Client **C1**, **C2**, **C3** and **C4**) simultaneously.

Figure 13 4X4:4 MU-MIMO



## 1.6 2.4/5 GHz MU-MIMO

The 802.11ac standard supports only downlink traffic on the 5 GHz band while 802.11ax supports both downlink and uplink connectivity on the 2.4GHz and 5GHz bands.

In a Mesh network, a downlink connection means transmitting data from an AP to a WiFi client. The AP serves as the transmitter and the WiFi client as the receiver. An uplink connection means transmitting data from a WiFi client to an AP. An Uplink connection means the AP is the receiver and the WiFi client, the transmitter.

Table 3 2.4/5GHz MU-MIMO

|              | TYPE     | 802.11b/g/n | 802.11ac | 802.11 ax |
|--------------|----------|-------------|----------|-----------|
| 2.4 GHz WLAN | Downlink | NA          | NA       | Y         |
|              | Uplink   | NA          | NA       | Y         |
| 5 GHz WLAN   | Downlink | NA          | Y        | Y         |
|              | Uplink   | NA          | N        | Y         |

## 1.7 Multicast (for WX3401-B0 only)

Traditionally, IP packets are transmitted in one of either two ways - Unicast (1 sender to 1 recipient) or Broadcast (1 sender to everybody on the network). Multicast delivers IP packets to a group of hosts on the network (1 sender to 1 or more recipients).

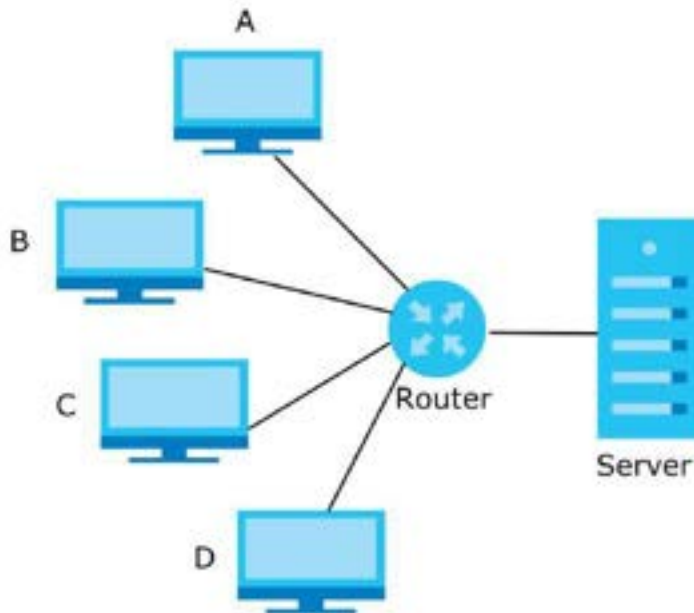
**Figure 14** Multicast Example

In the multicast example above, systems A and D comprise one multicast group. In multicasting, the server only needs to send one data stream and this is delivered to systems A and D.

IGMP (Internet Group Multicast Protocol) is a network-layer protocol used to establish membership in a Multicast group - it is not used to carry user data. IGMP version 2 (RFC 2236) is an improvement over version 1 (RFC 1112) but IGMP version 1 is still in wide use. IGMP version 3 supports source filtering, reporting or ignoring traffic from specific source address to a particular host on the network.

A class D IP address is used to identify host groups and can be in the range 224.0.0.0 to 239.255.255.255. The address 224.0.0.0 is not assigned to any group and is used by IP multicast computers. The address 224.0.0.1 is used for query messages and is assigned to the permanent group of all IP hosts (including gateways). All hosts must join the 224.0.0.1 group in order to participate in IGMP. The address 224.0.0.2 is assigned to the multicast routers group.

At start up, the WX Device queries all directly connected networks to gather group membership. After that, the WX Device periodically updates this information.

# CHAPTER 2

## Hardware

This section describes the front and back panel of the WX Device. Refer to the Quick Start Guides to see how to make the hardware connections.

### 2.1 Front Panel and LEDs

Use the LEDs to determine if the WX Device is behaving normally or if there are problems on your network.

See [Table 5 on page 23](#) and [Table 6 on page 24](#) for more information on the LEDs.

**Figure 15** The WX3401-B0's Front Panel



**Figure 16** The WX3100-T0's Front Panel



## 2.2 Rear Panel

**Figure 17** The WX3401-B0's Rear Panel



Figure 18 The WX3100-T0's Rear Panel



Table 4 Panel Ports and Buttons

| LABEL                 | DESCRIPTION   |
|-----------------------|---|
| LAN1/LAN2             | Connect computers or other Ethernet devices to Ethernet ports for Internet access.    |
| WPS                   | Press the <b>WPS</b> button once within eight seconds to enable the AP/Repeater mode. |
| POWER ON/OFF or DC/IN | Connect the power cable and then press the power button to start the device.          |
| RESET                 | Press the button to return the WX Device to the factory defaults.                     |

## 2.3 LEDs (Lights)

None of the LEDs are on if the Zyxel Device is not receiving power.

Table 5 LED Table (for the WX Device-1)



| LED  | COLOR | STATUS   | DESCRIPTION   |
|--|-------|----------|---|
| POWER<br>                         | Green | On       | Power is on or the MPro Mesh configuration process is done.                               |
|  |       | Blinking | The WX Device is starting up or under the MPro Mesh configuration process.                |
|  | Red   | On       | The WX Device detects a system error.   |
|  |       | Blinking | The WX Device is upgrading firmware.  |
| Link (With a WiFi connection)<br> | Green | On       | The WiFi connection to the MPro Mesh router is good.                                      |
|  | Amber | On       | The signal is too strong. We suggest moving the WX Device away from the MPro Mesh Router. |
|  | Red   | On       | The signal is too weak. Move the WX Device closer to the MPro Mesh Router.                |

Table 5 LED Table (for the WX Device-1)









| LED   | COLOR | STATUS   | DESCRIPTION   |
|---|-------|----------|---|
| Link (With a wired connection)<br> | Green | On       | The Ethernet cable is connected to the LAN port on the WX Device.                           |
| WiFi<br>                           | Green | On       | The 2.4 G/5 G WiFi is ready.  |
|   |       | Blinking | The WX Device is transmitting/receiving WiFi data.  |
|   |       | Off      | The 2.4 G/5 G WiFi is disabled.   |
| WPS (for WX3100-T0 only)<br>       | Amber | Blinking | If you press the WPS button, amber blinking within 120 seconds means the WPS is in process. |
|   |       | Off      | The WPS process is done.  |

Table 6 LED Table (for the WX Device-2)

| LED   | COLOR | STATUS   | DESCRIPTION   |
|---|-------|----------|---|
| POWER<br>                            | Green | On       | Power is on or the MPro Mesh configuration process is done.                                 |
|   |       | Blinking | The WX Device-2 is starting up or under the MPro Mesh configuration process.                |
|   | Red   | On       | The WX Device-2 detects a system error.   |
|   |       | Blinking | The WX Device-2 is upgrading firmware   |
| Link (with a WiFi connection)<br>  | Green | On       | The WiFi connection to the WX Device-1 is good.   |
|   | Amber | On       | The signal is too strong. We suggest moving the WX Device-2 away from the WX Device-1.      |
|   | Red   | On       | The signal is too weak. Move the WX Device-2 closer to the WX Device-1.                     |
| Link (with a wired connection)<br> | Green | On       | The Ethernet cable is connected to the LAN port on the WX Device-2.                         |
| WiFi<br>                           | Green | On       | The 2.4 G/5 G WiFi is ready.  |
|   |       | Blinking | The WX Device-2 is transmitting/receiving WiFi data.  |
|   |       | Off      | The 2.4 G/5 G WiFi is disabled.   |
| WPS (for WX3100-T0 only)<br>       | Amber | Blinking | If you press the WPS button, amber blinking within 120 seconds means the WPS is in process. |
|   |       | Off      | The WPS process is done.  |



## 2.4 Wall Mounting

Do the following to attach your WX Device to a wall.

### 2.4.1 The WX3401-B0 Wall-Mounting

You may need screw anchors if mounting on a concrete or brick wall.

Table 7 The WX3401 Wall Mounting Information

|                          |          |
|--------------------------|----------|
| Distance between holes   | 89.00 mm |
| M4 Screws                | Two      |
| Screw anchors (optional) | Two      |

Figure 19 The WX3401 Screw Specifications

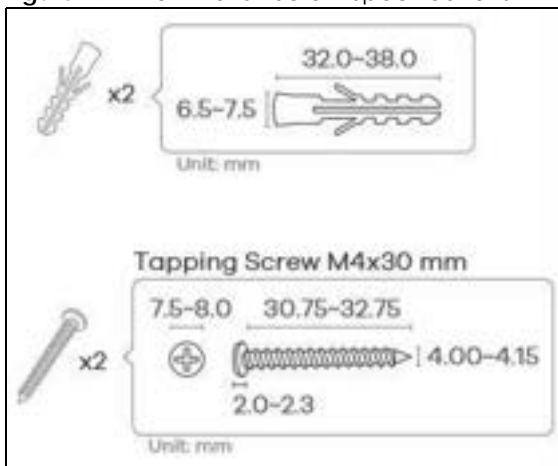

- 1 Select a position free of obstructions on a wall strong enough to hold the weight of the device.
- 2 Mark two holes on the wall at the appropriate distance apart for the screws.

**Be careful to avoid damaging pipes or cables located inside the wall when drilling holes for the screws.**

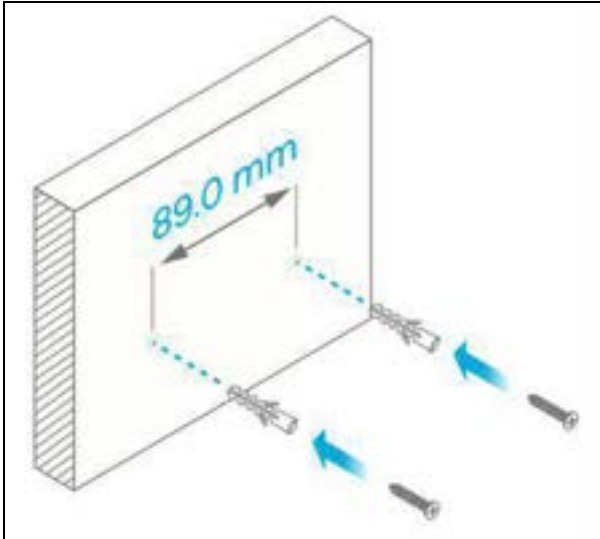
**Figure 20** The WX3401 Wall Mounting Distance

- 3 If using screw anchors, drill two holes for the screw anchors into the wall. Push the anchors into the full depth of the holes, then insert the screws into the anchors. Do not insert the screws all the way in - leave a small gap of about 0.5 cm.  
If not using screw anchors, use a screwdriver to insert the screws into the wall. Do not insert the screws all the way in - leave a gap of about 0.5 cm.
- 4 Make sure the screws are fastened well enough to hold the weight of the WX Device with the connection cables.
- 5 Align the holes on the back of the WX Device with the screws on the wall. Hang the WX Device on the screws.

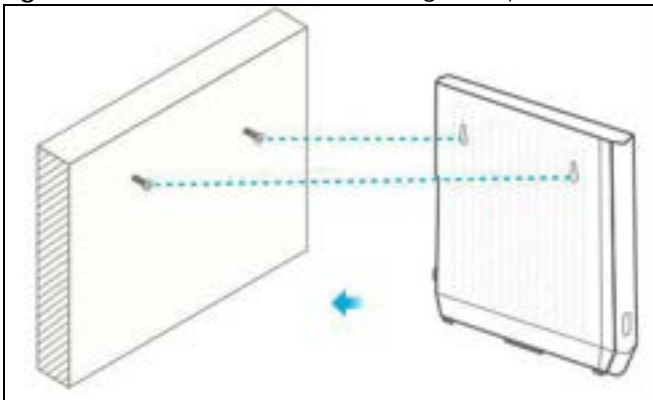
**Figure 21** The WX3401 Wall Mounting Example

## 2.4.2 The WX3100-T0 Wall-Mounting

You may need screw anchors if mounting on a concrete or brick wall.

Table 8 The WX3100 Wall Mounting Information

|                          |     |
|--------------------------|-----|
| M4 Screws                | One |
| Screw anchors (optional) | One |

Figure 22 The WX3100 Screw Specifications

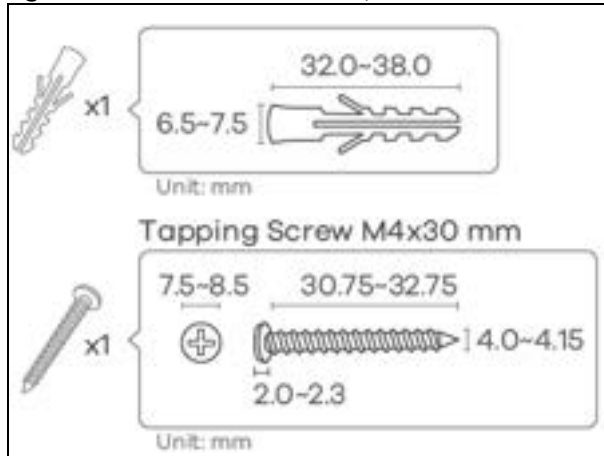

- 1 Attach the bracket to the back of the WX3100-T0 as shown.

Figure 23 Attach the bracket

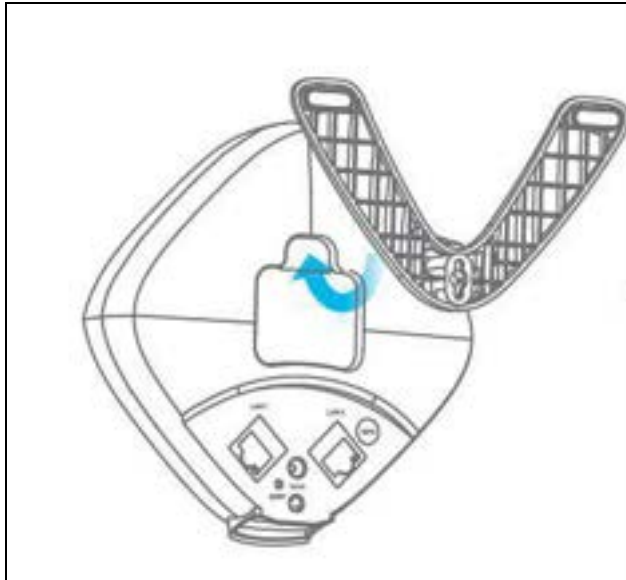

- 2 Drill a hole in the wall. Insert the screw anchor and screw into the hole.
- 3 Place the WX3100-T0 so the wall mount hole lines up with the screw. Slide the WX3100-T0 down gently to fix it into place.

Figure 24 Wall Mounting

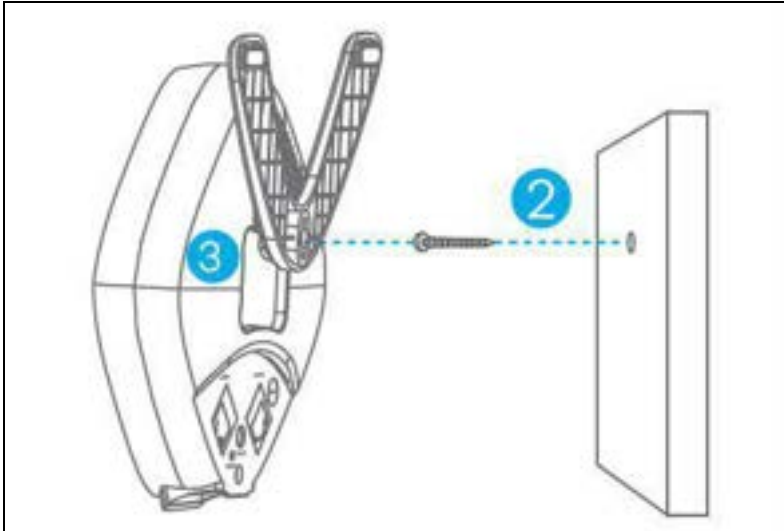

## 2.5 WPS Button

Your WX Device supports WiFi Protected Setup (WPS), which is an easy way to set up a secure WiFi network. WPS is an industry standard specification, defined by the Wi-Fi Alliance.

WPS allows you to quickly set up a WiFi network with strong security, without having to configure security settings manually. Each WPS connection works between two devices. Both devices must support WPS (check each device's documentation to make sure).

Depending on the devices you have, you can either press a button (recommended) on the device itself, or in its web configurator. When WPS is activated on a device, it has two minutes to find another device that also has WPS activated. Then, the two devices connect and set up a secure network by themselves.

The **WPS** button is located at the front panel of the WX Device.

### 2.5.1 Using the WPS Button

- 1 Make sure the power LED is on (not blinking).
- 2 Choose a mode
  - APC mode
    1. Press the WX Device **WPS** button once. The WPS LED should start blinking.
    2. Press the WPS button on the client within 2 minutes.
  - AP Mode (Downlink Daisy Chain For MPro Mesh)
    1. Press the first WX Device **WPS** button once.
    2. Press the **WPS** button once on the downlink WX Device within 2 minutes of each other.

- Repeater mode (modem/router to the WX Device)
  1. Press the WPS button on the modem/router. Release it when the WPS LED blinks.
  2. Press the WX Device **WPS** button once within 2 minutes to copy the WiFi settings from your modem/router to the WX Device.
  3. The Link LED lights up when the process is finished.
- Repeater mode (the WX Device to the WiFi client)
  1. Press the WX Device **WPS** button twice within 8 seconds to copy the WiFi settings from the WX Device to a WiFi client, such as your smartphone or laptop.
  2. Wait until the WPS LED blinks.
  3. Press the WPS button on the client within 2 minutes.
- Repeater mode (Downlink Daisy Chain For MPro Mesh)
  1. Press the first WX Device **WPS** button twice within 8 seconds.
  2. Press the **WPS** button once on the downlink WX Device within 2 minutes of each other.

Note: You must activate WPS in the WX Device and in another wireless device within two minutes of each other.

Note: With WPS, WiFi clients can only connect to the 5 GHz or 2.4 GHz WiFi network using the first 5 GHz or 2.4 GHz SSID on the WX Device (in AP or repeater mode).

## 2.6 RESET Button

If you forget your password or you cannot access the Web Configurator, you will need to use the **RESET** button at the back of the WX Device to reload the factory-default configuration file. This means that you will lose all configurations that you had previously saved, the password will be reset to the default key on the device label.

### 2.6.1 Using the RESET Button

- 1 Make sure the power LED is on (not blinking).
- 2 Press the **RESET** button for longer than five seconds to set the WX Device back to its factory-default configurations.

# CHAPTER 3

## The Web Configurator

### 3.1 Overview

The Web Configurator is an HTML-based management interface that allows easy system setup and management via Internet browser. Use a browser that supports HTML5, such as Microsoft Edge, Internet Explorer 11, Mozilla Firefox, or Google Chrome. The recommended screen resolution is 1024 by 768 pixels.

In order to use the Web Configurator you need to allow:

- Web browser pop-up windows from your device.
- JavaScript (enabled by default).
- Java permissions (enabled by default).

### 3.2 Accessing the Web Configurator

#### 3.2.1 When the WX Device is connected to a modem/router

When your WX Device is in the AP mode:

- 1 Connect your computer to the LAN port of the WX Device using an Ethernet cable.
- 2 Connect your computer to a LAN port of the router. Log into the router's Web Configurator to check the IP address the router assigned to your WX Device.
- 3 Open a web browser such as Internet Explorer and type "http:// (DHCP-assigned IP)" as the web address in your web browser.
- 4 Log into the Web Configurator.

When your WX Device is in the Repeater mode:

- 1 Connect a modem/router to the first WX Device wirelessly.
- 2 Connect your computer to a LAN port of the router. Log into the router's Web Configurator to check the IP address the router assigned to your WX Device.
- 3 Open a web browser such as Internet Explorer and type "http:// (DHCP-assigned IP)" as the web address in your web browser.
- 4 Log into the Web Configurator.

### 3.2.2 When the WX Device is not connected to a router/modem:

- 1 Make sure your WX Device hardware is properly connected (refer to the Quick Start Guide).
- 2 Give your computer a fixed IP address in the range between 192.168.1.3 and 192.168.1.254.
- 3 After you have set your computer's IP address, open a web browser such as Internet Explorer and enter "http://192.168.1.2" as the web address in your web browser.
- 4 Log into the Web Configurator.
- 5 A login screen displays. Select the language you prefer.
- 6 To access the administrative Web Configurator and manage the WX Device, type the default username **admin** and the randomly assigned default password (see the device label) on the login screen and click **Login**. If you have changed the password, enter your password and click **Login**.

Figure 25 Login Screen

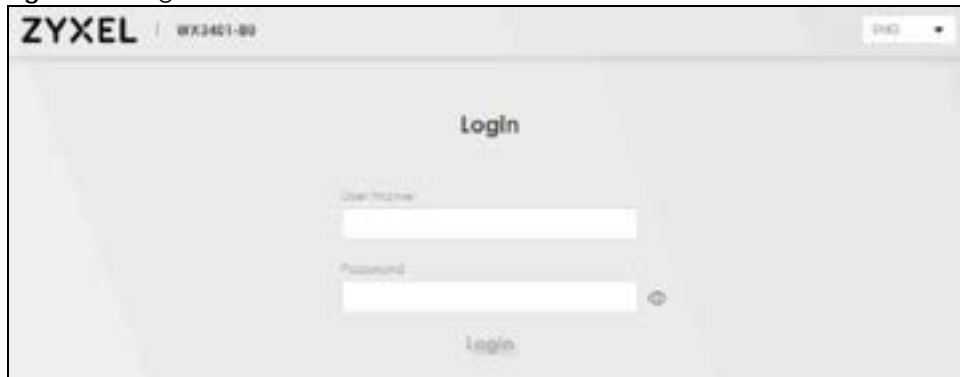

Note: The default allowable times that you can enter the **Password** is 3. If you entered the wrong password for the fourth time, by default the Web Configurator will lock itself for 5 minutes before you can try entering the correct **Password** again. You can change these settings at **Maintenance > User Account > Add New / Edit Account** (see [Section 13.2.1 on page 136](#)).

- 7 The following screen displays when you log into the Web Configurator for the first time. Enter a new password, retype it to confirm, and click **Change password**. If you prefer to use the default password, click **Skip**.

Figure 26 Change Password Screen

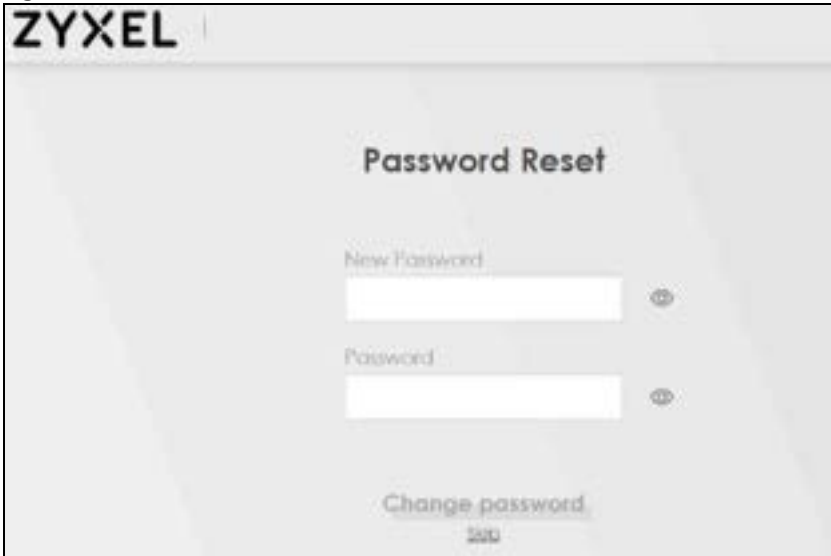

- 8 The **Connection Status** page appears. Use this screen to configure basic Internet access and wireless settings (see [Section 6.1 on page 83](#) for details).

Figure 27 Connection Status

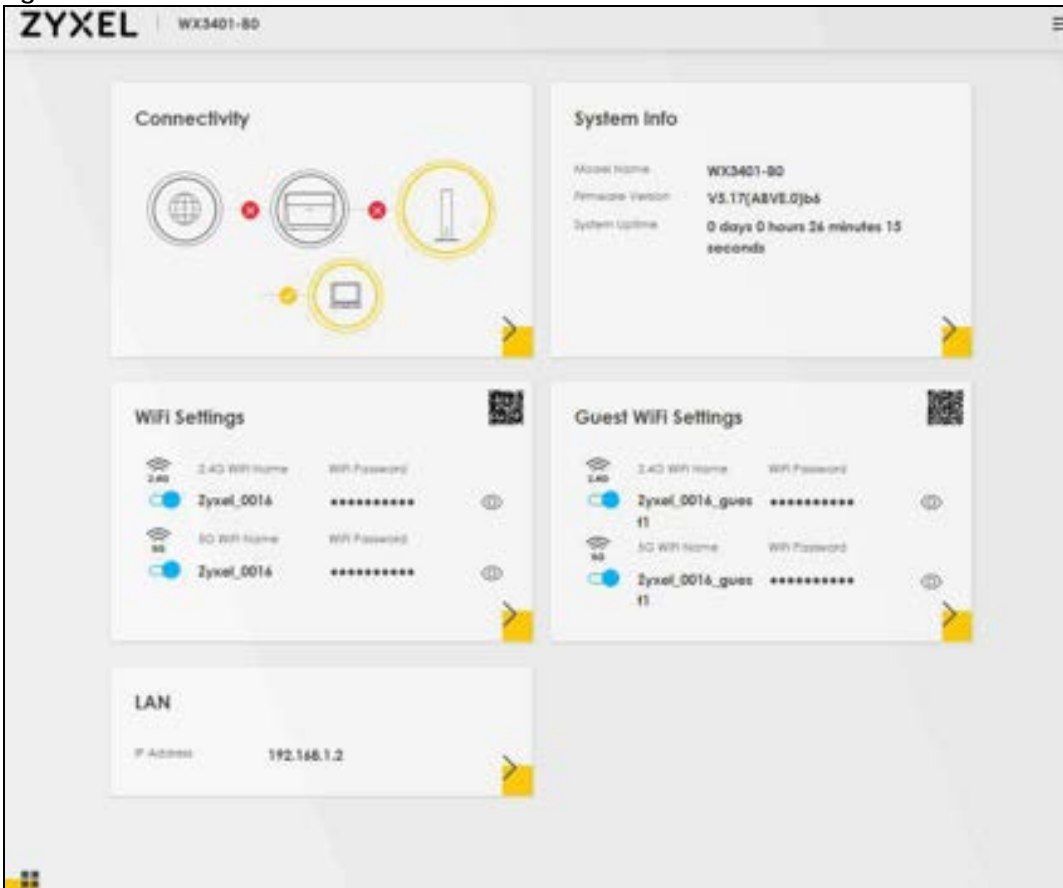



## 3.3 Web Configurator Layout

Figure 28 Screen Layout

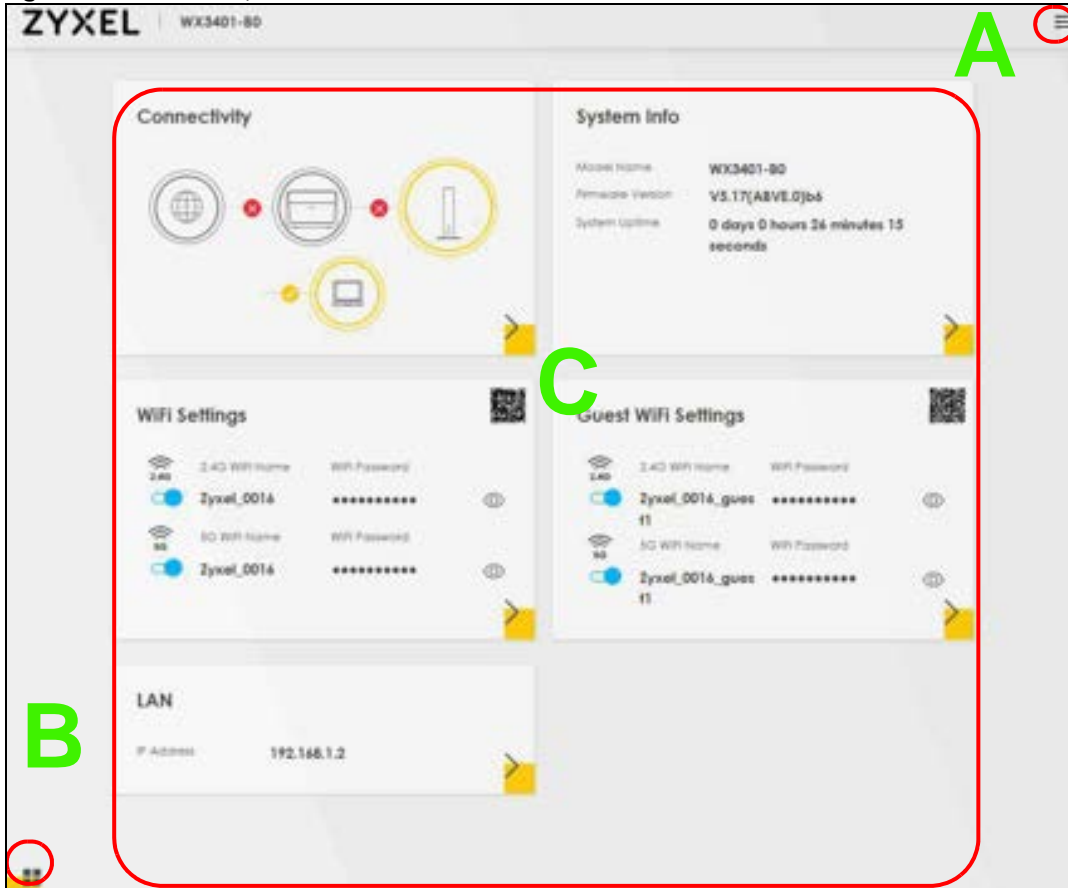

As illustrated above, the main screen is divided into these parts:

- A - Navigation Panel
- B - Layout Icon
- C - Main Window

### 3.3.1 Navigation Panel

Click the menu icon (☰) to display the navigation panel that contains configuration menus and icons (quick links). Click X to close the navigation panel.

Figure 29 Navigation Panel

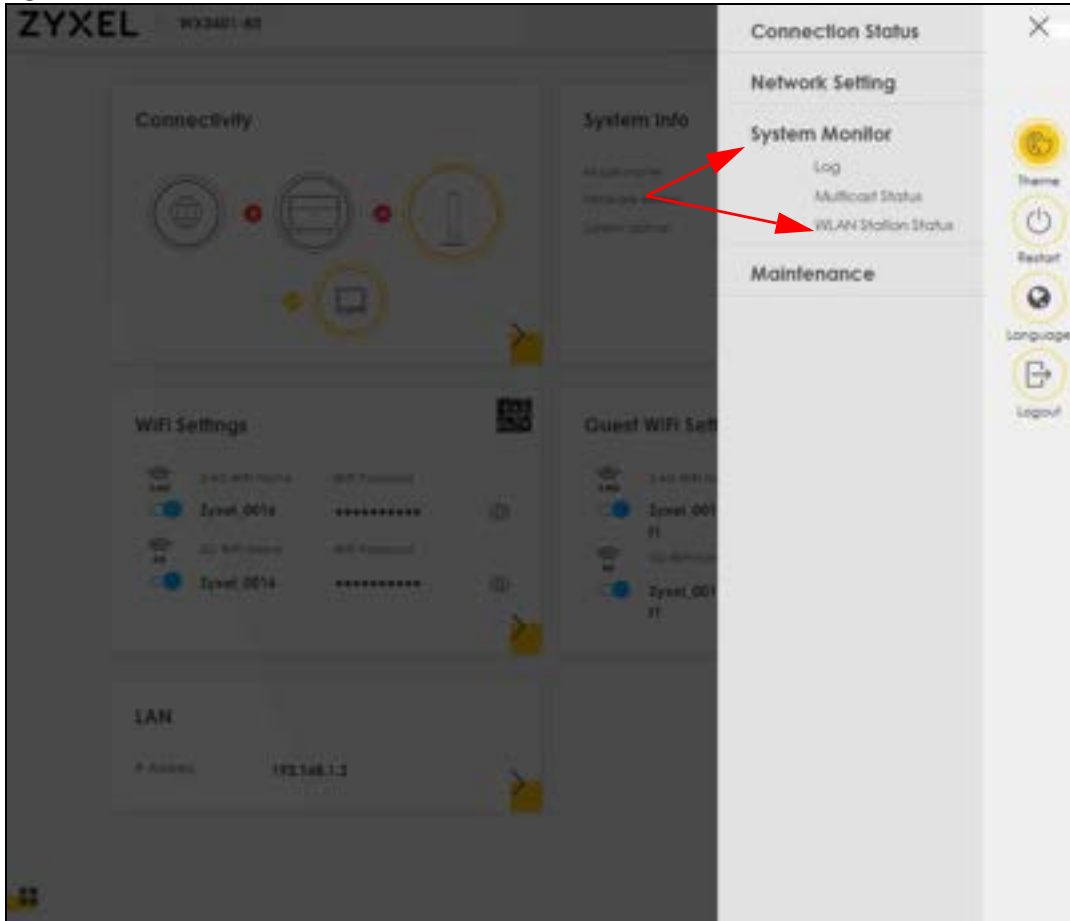

### 3.3.1.1 Configuration Menus

Use the menu items on the navigation panel to open screens to configure WX Device features. The following tables describe each menu item.

Table 9 Configuration Menus Summary

| LINK              | TAB | FUNCTION  |
|-------------------|-----|---|
| Connection Status |     | Use this screen to configure basic Internet access and wireless settings. This screen also shows the network status of the WX Device and computers/devices connected to it. |
| Network Setting   |     |   |

Table 9 Configuration Menus Summary (continued)

| LINK                | TAB                            | FUNCTION   |
|---------------------|--------------------------------|--|
| Wireless            | General                        | Use this screen to configure the WiFi settings and wireless LAN authentication/security settings.  |
|                     | Guest/More AP<br>Guest/More AP | Use this screen to configure multiple BSSs on the WX Device.   |
|                     | MAC Authentication             | Use this screen to block or allow wireless traffic from wireless devices of certain SSIDs and MAC addresses to the WX Device.                      |
|                     | WPS                            | Use this screen to configure and view your WPS (WiFi Protected Setup) settings.  |
|                     | WMM                            | Use this screen to enable or disable WiFi MultiMedia (WMM).  |
|                     | Others                         | Use this screen to configure advanced wireless settings.   |
|                     | Channel Status                 | Use this screen to scan WiFi channel noises and view the results.  |
|                     | Operating Modes                | Use this screen to enter the SSID and configure the wireless security between the WX Device and the wireless network to which you want to connect. |
|                     | AP List                        | Use this screen to scan the wireless networks in the WX Device's area.   |
| Home Networking     | Home Networking                | Use this screen to configure DHCP/Static IP settings, and other advanced properties.   |
| System Monitor      |                                |  |
| Log                 | Log                            | Use this screen to view the status of events that occurred to the WX Device. You can export or e-mail the logs.                                    |
| Multicast Status    | IGMP Status                    | Use this screen to view the status of all IGMP settings on the WX Device.  |
|                     | MLD Status                     | Use this screen to view the status of all MLD settings on the WX Device.   |
| WLAN Station Status | WLAN Station Status            | Use this screen to view the wireless stations that are currently associated with the WX Device.  |
| Maintenance         |                                |  |
| System              | System                         | Use this screen to set Device name.  |
| User Account        | User Account                   | Use this screen to change user password on the WX Device.  |
| Remote Management   | Remote Management              | Use this screen to enable specific traffic directions for network services.  |
| Time                | Time                           | Use this screen to change your WX Device's time and date.  |
| Firmware Upgrade    | Firmware Upgrade               | Use this screen to upload firmware to your WX Device.  |
| Backup/Restore      | Backup/Restore                 | Use this screen to backup and restore your WX Device's configuration (settings) or reset the factory default settings.                             |
| Reboot              | Reboot                         | Use this screen to reboot the WX Device without turning the power off.   |
| Diagnostic          | Ping&Traceroute                | Use this screen to identify problems with the WX Device. You can use Ping or TraceRoute to help you identify problems.                             |





### 3.3.1.2 Icons

The navigation panel provides some icons on the right hand side.

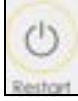

The icons provide the following functions.

Table 10 Web Configurator Icons

| ICON  | DESCRIPTION   |
|---|---|
| <br>Theme     | <p><b>Theme:</b> Click this icon to select a color that you prefer and apply it to the Web Configurator.</p>  |
| <br>Restart  | <p><b>Restart:</b> Click this icon to reboot the WX Device without turning the power off.</p>   |
| <br>Language | <p><b>Language:</b> Select the language you prefer.</p>   |
| <br>Logout   | <p><b>Logout:</b> Click this icon to log out of the Web Configurator.</p>   |

---

# PART II

## Technical Reference

---

# CHAPTER 4

## App Tutorials

### 4.1 Overview

This shows you how to use the MPro Mesh app to manage the WX Device and its Mesh network.

### 4.2 What You Can Do

- To set up your WX Device with a Zyxel MPro Mesh Router using a WiFi connection; see [Section 4.3.1 on page 38](#).
- To set up your WX Device with a non-MPro Mesh Router using a wired connection; see [Section 4.3.2 on page 43](#).
- Use the **Home** screen to reboot your WX Device or add WX Devices to your network; see [Section 4.4 on page 50](#).
- Use the **Devices** screen to view the information of WiFi clients connected to the WX Device; see [Section 4.5 on page 62](#).
- Use the **WiFi Settings** screen to configure your main or guest WiFi network; see [Section 4.6 on page 64](#).
- Use the **Account** screen to view your app version or logout; see [Section 4.8 on page 70](#).

### 4.3 Network Setup

There are several ways to set up your WX Device. You can set it up with a Zyxel MPro Mesh Router using a wired or WiFi connection. Alternatively, you can set it up with a non-MPro Mesh Router with a wired connection. This section shows you how to connect to a Zyxel MPro Mesh router wirelessly and how to connect to a non-MPro Mesh router with an Ethernet cable. See the following table for more information.

Table 11 Network Setup Scenario

| SCENARIO  | Zyxel MPro Mesh Router                              | Non-Zyxel MPro Mesh Router                          |
|---|---|---|
| Wired Connection from the router to the WX Device | Yes   | Yes (see <a href="#">Section 4.3.2 on page 43</a> ) |
| WiFi Connection from the router to the WX Device  | Yes (see <a href="#">Section 4.3.1 on page 38</a> ) | No  |

#### 4.3.1 Setting up the WX Device with a Zyxel MPro Mesh Router

Follow the steps below to set up your WX Device with the Zyxel MPro Mesh Router. This section uses the WX3401-B0 and DX5301-B0 as an example.

- 1 Download the MPro Mesh app from Google Play or Apple Store.



- 2 Connect your mobile device to the WiFi network of the Zyxel MPro Mesh Router. Note the SSID and password on the back label of the Zyxel MPro Mesh Router. Find this SSID on your mobile device. Enter the key to connect to your router.

Note: The Zyxel MPro Mesh Router is the wireless controller, so you must connect to it to use the MPro Mesh app to manage WiFi settings.

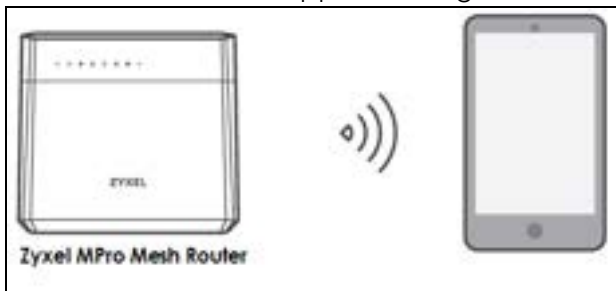

- 3 Connect the MPro Mesh App to the Zyxel MPro Mesh Router. Open the app, enter the username and password on the back label of your Zyxel MPro Mesh Router to log in the Home page of the App.



- 4 Rotate the stand on the bottom of the WX Device 90 degrees.

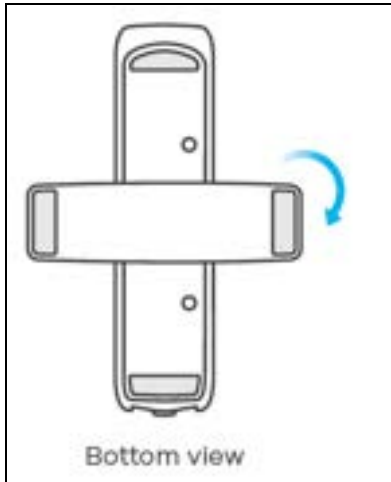

- 5 Place the WX Device where you want to extend the coverage of your WiFi network.

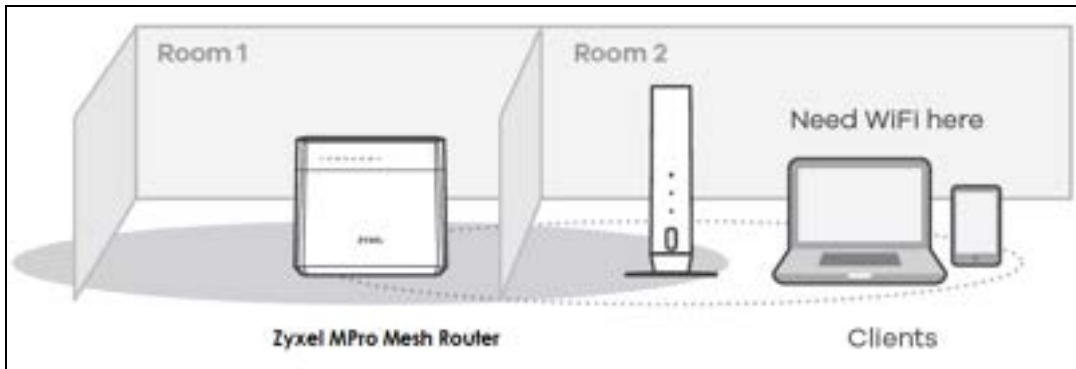

- 6 Plug in the power cable and switch on the WX Device. Wait until the **POWER** LED turns steady green. This may take up to 2.5 minutes.

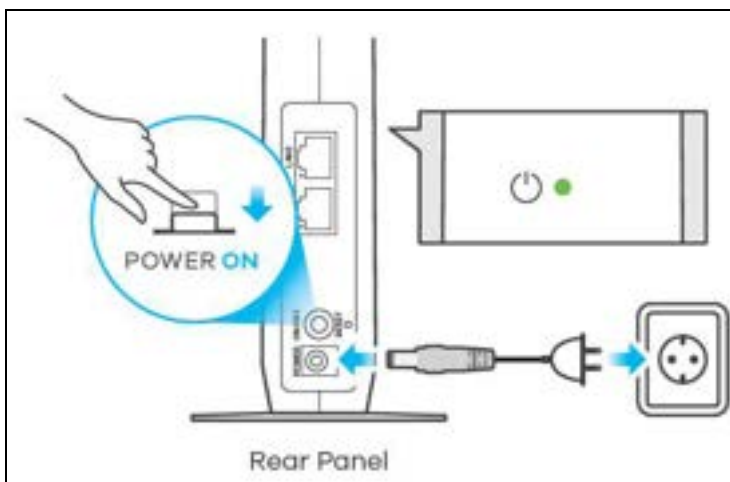

- 7 Open the MPro Mesh App. On the **Home** screen, tap on the **+** icon to add a WX Device.



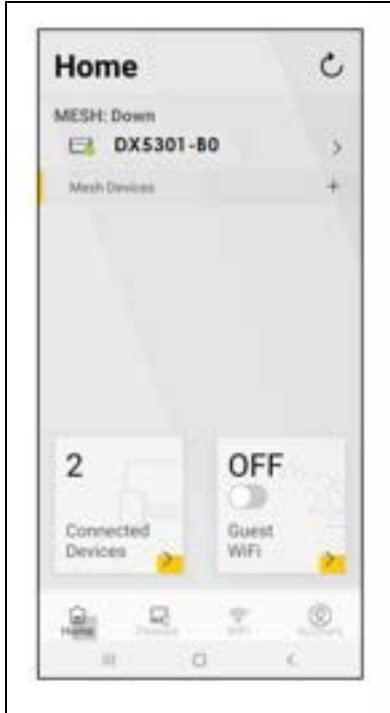

- 8 Select the **Use WiFi** scenario. Follow the instructions to start pairing the WX Device with a Zyxel MPro Mesh Router (with the WX3401-B0 and the DX5301-B0 as an example). Once the pairing starts, a 2-minute countdown timer will begin.

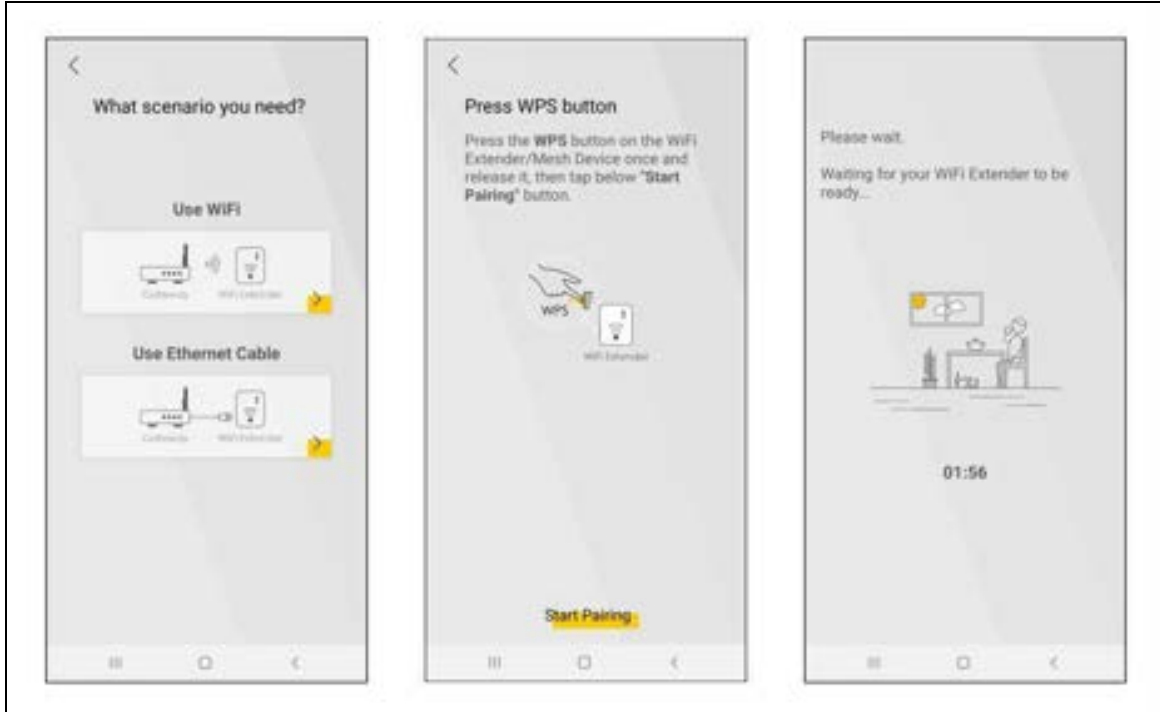

- 9 Within 2 minutes, press the WPS button once on the WX Device until WiFi LED starts blinking slowly.

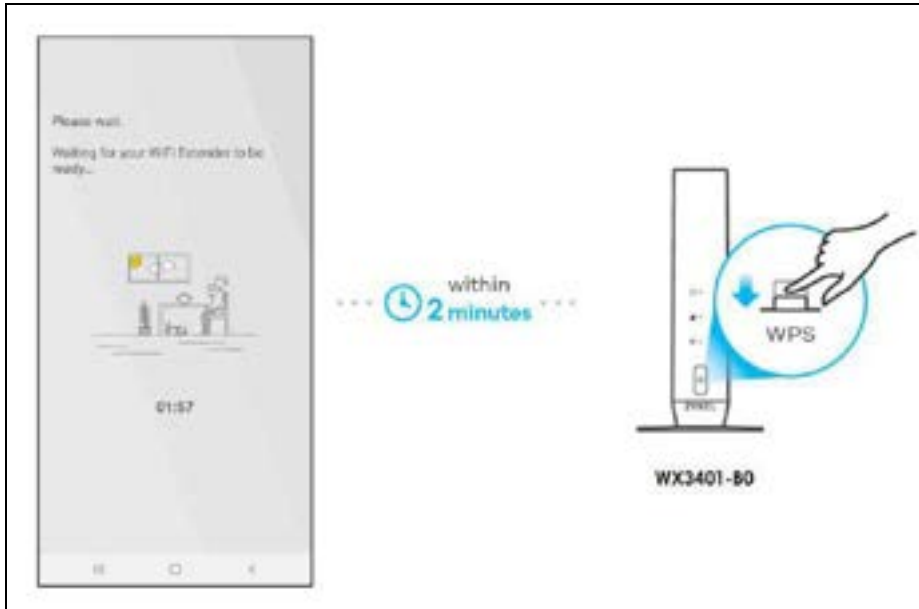

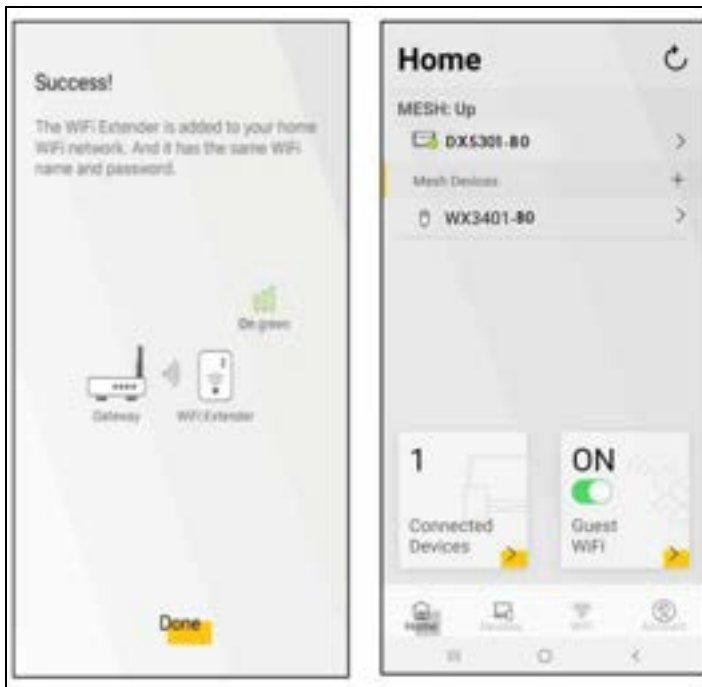

- 10 After the WIFI LED turns steady green or fast blinking, wait for up to 2 minutes. The POWER LED should start blinking. The **POWER** and **Link** LED will turn solid green if the pairing process is successful. You can also check the result on the app screen.
- 11 Click **Done** to finish the pairing process. The Mpro Mesh Router (the controller) will undergo an auto-configuration after a Mesh network is established. (See [Section 1.2 on page 13](#) for more information.) Check the status of your MPro Mesh network on the **Home** screen.



- 12 The **POWER** LED shows if the WX Device is ready to join the WiFi network. The **LINK** LED shows the WiFi link quality. See [Section Table 12 on page 43](#) for more information on LED behaviors.

Table 12 LED Table (for WX Device-1)

| LED   | COLOR | STATUS   | DESCRIPTION   |
|---|-------|----------|---|
| POWER                          | Green | On       | Power is on or the MPro Mesh configuration process is done.                               |
|   |       | Blinking | The WX Device is starting up or under the MPro Mesh configuration process.                |
|   | Red   | On       | The WX Device detects a system error.   |
|   |       | Blinking | The WX Device is upgrading firmware.  |
| Link (With a WiFi connection)  | Green | On       | The WiFi connection to the MPro Mesh router is good.                                      |
|   | Amber | On       | The signal is too strong. We suggest moving the WX Device away from the MPro Mesh Router. |
|   | Red   | On       | The signal is too weak. Move the WX Device closer to the MPro Mesh Router.                |

### 4.3.2 Setting up the WX Device with a Non-MPro Mesh Router

This scenario describes the process to create a Mesh network with a wired connection from the non-MPro Mesh router to the first WX Device (WX Device -1). This section uses a non-MPro Mesh Router, the WX3401-1, and WX3401-2 as an example.

Make sure the non-MPro Mesh Router is connected to the Internet. The first WX Device (WX Device-1) must be connected to your router using an Ethernet cable. Then, connect the second WX Device (WX Device-2) wirelessly to the first WX Device (WX Device-1).

Follow the steps below to set up the WX Device-1 with a non-MPro Mesh Router.

#### Connect the WX Device-1 to the Non-MPro Mesh Router

- 1 Use an Ethernet cable to connect the WX Device-1 to your non-MPro Mesh Router.

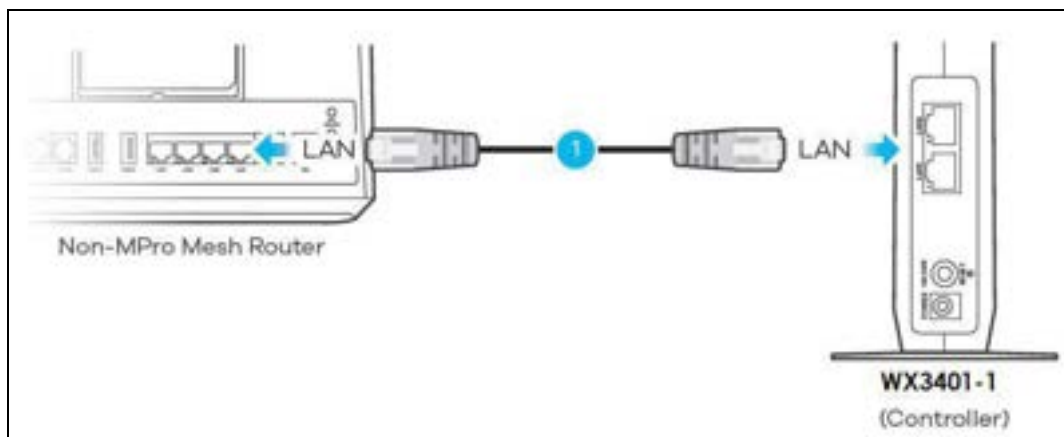

- 2 Rotate the stand on the bottom of the WX Device-1 90 degrees.

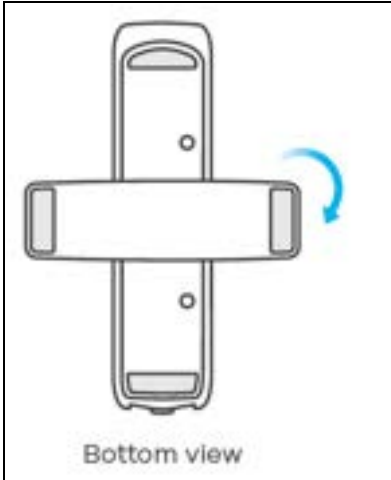

- 3 Plug in the power cable and switch on the WX Device-1. Wait until the **POWER** LED turns steady green. This may take up to 2.5 minutes.

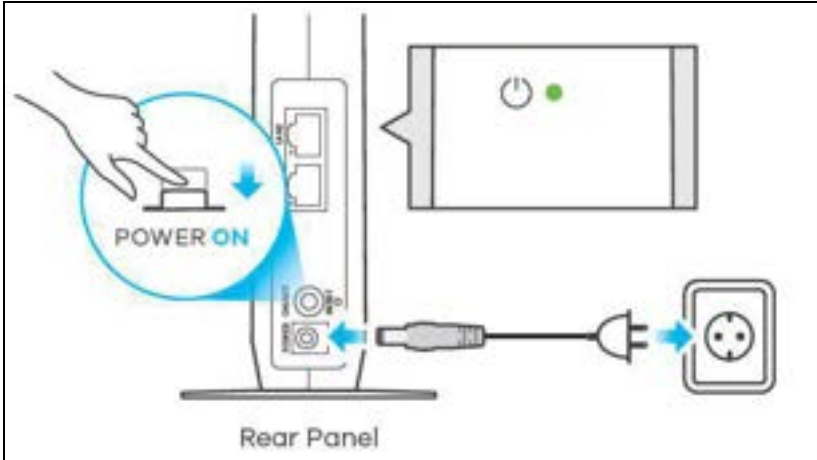

- 4 On your mobile device, go to the WiFi settings. Long press your existing WiFi connection. Tap **Forget network** to remove your existing WiFi connection.

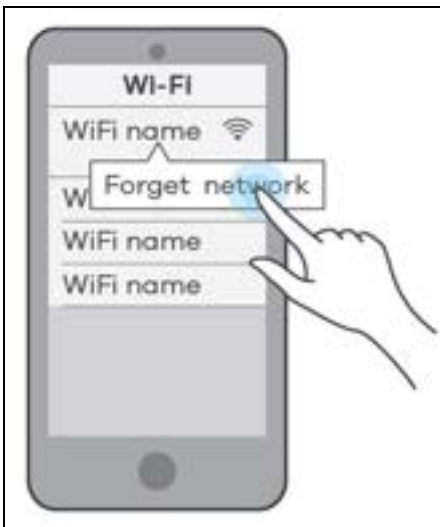

- 5 Connect your mobile device to the WiFi network of the WX Device-1. Note the SSID and key on the side label of the WX Device-1. Find this SSID on your mobile device. Enter the key to connect to your WX Device-1.

Note: In this scenario, WX Device-1 is the wireless controller, so you must connect to it to use the MPro Mesh app to manage the WiFi network.

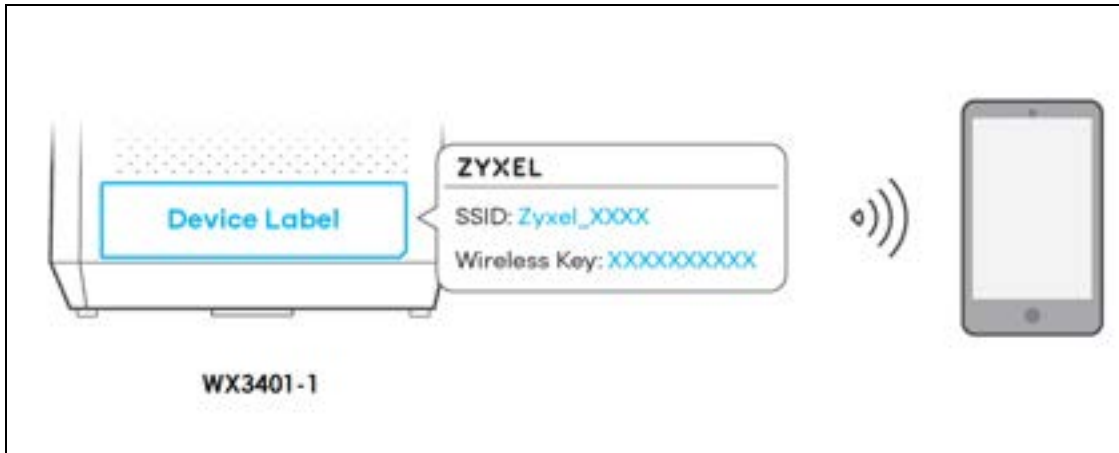

- 6 Download the MPro Mesh App from Google Play or Apple Store.



- 7 Connect the MPro Mesh App to the WX Device-1. Open the app, enter the username and password on the side label of the WX Device-1 when prompted.

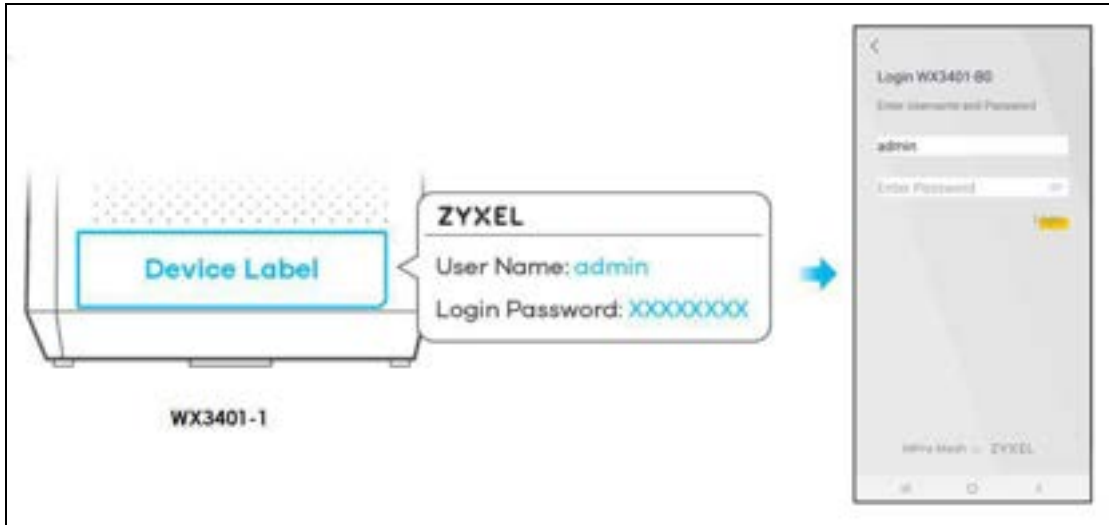

### Connect the WX Device-2 to the WX Device-1

- 1 Rotate the stand on the bottom of the WX Device-2 90 degrees.

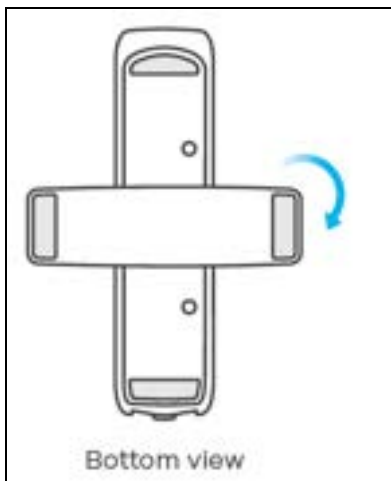

- 2 Place the WX Device-2 where you want to extend the coverage of your network.

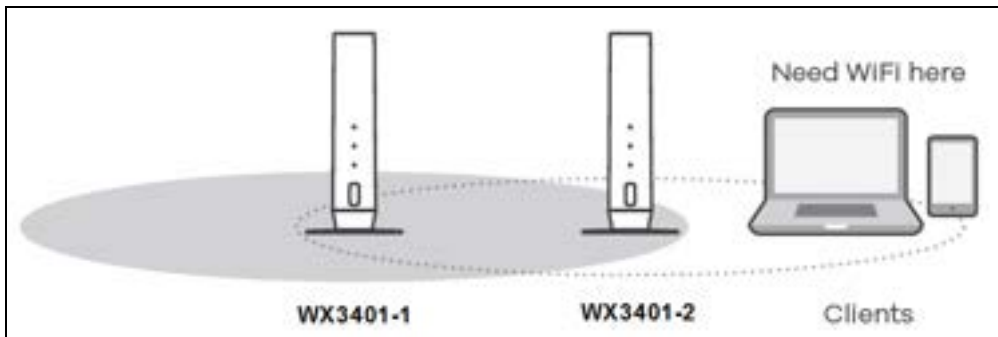

- 3 Plug in the power cable and switch on the WX Device-2. Wait until the **POWER** LED turns steady green. This may take up to 2.5 minutes.

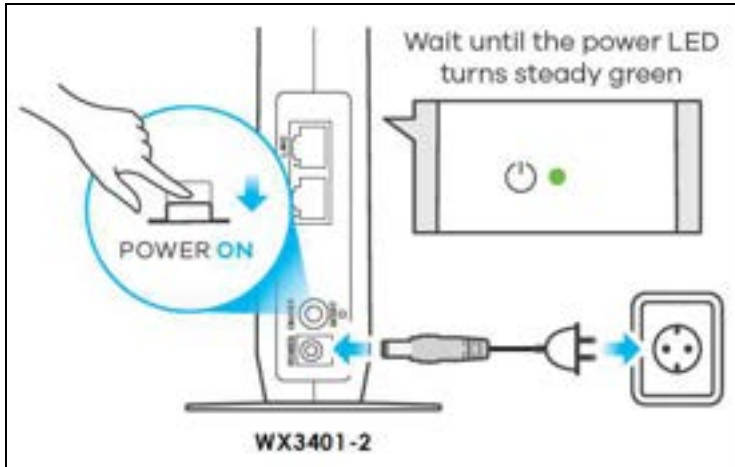

- 4 When the **POWER** LED on the WX Device-2 is steady green, open the MPro Mesh App. On the **Home** screen, tap on the **+** icon to add the WX Device-2.



- 5 Select the **Use WiFi** scenario. Follow the instructions to start pairing the WX Device-2 with the WX Device-1. Once the pairing starts, a 2-minute countdown timer will begin.

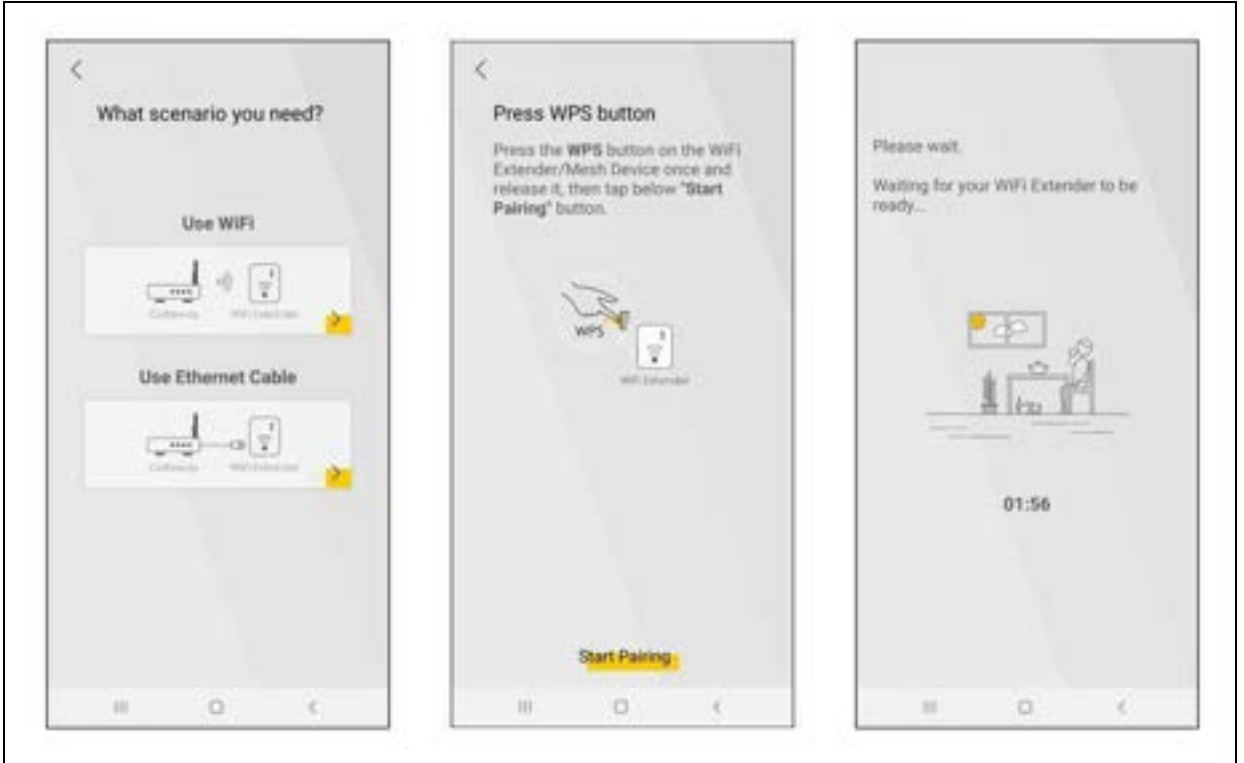

- 6 Within 2 minutes, press the WPS button once on the WX Device-2 for less than 3 seconds.

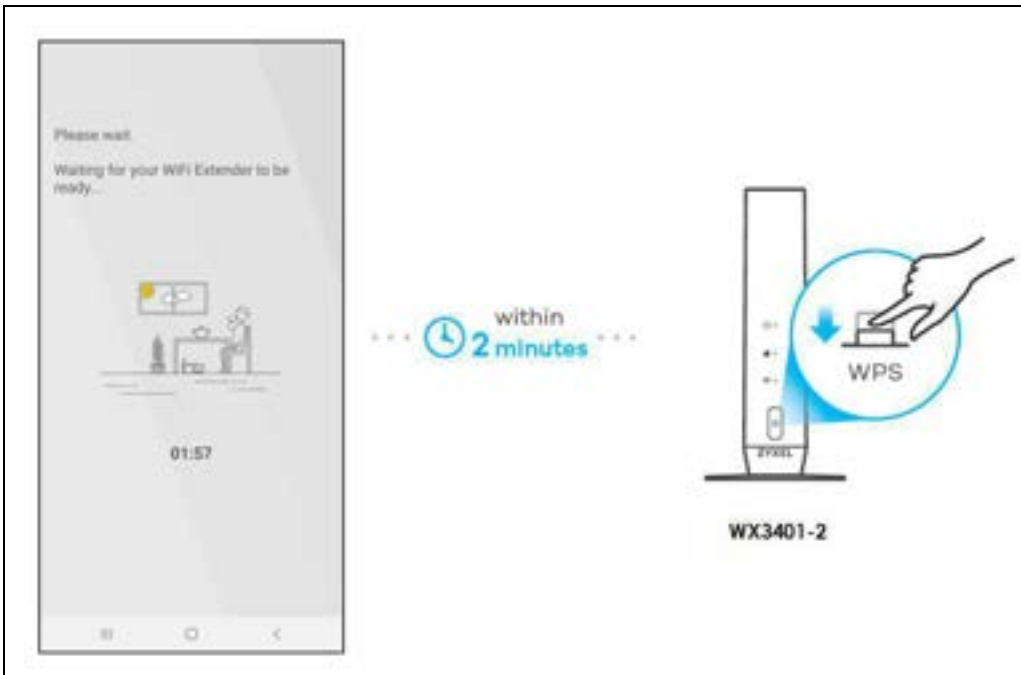

- 7 The **POWER** and **Link** LED on the WX Device-2 turns steady green if the pairing process is successful. You can also check the result on the app screen.





- 8 Click **Done** to finish the pairing process. The WX Device-1 (the controller) will undergo an auto-configuration after a Mesh network is established. (See [Section 1.2 on page 13](#) for more information). Check the status of your wireless Mesh network on the **Home** screen.



- 9 The **POWER** LED shows if the WX Device-2 is ready to join the WiFi network. The **LINK** LED shows the WiFi link quality. See [Section Table 13 on page 49](#) for more information on LED behaviors.

Table 13 LED Table (for WX Device-2)

| LED   | COLOR | STATUS   | DESCRIPTION  |
|---|-------|----------|--|
| POWER                          | Green | On       | Power is on or the MPro Mesh configuration process is done.                            |
|   |       | Blinking | The WX Device-2 is starting up or under the MPro Mesh configuration process.           |
|   | Red   | On       | The WX Device-2 detects a system error.  |
|   |       | Blinking | The WX Device-2 is upgrading firmware  |
| Link (with a WiFi connection)  | Green | On       | The WiFi connection to the WX Device-1 is good.  |
|   | Amber | On       | The signal is too strong. We suggest moving the WX Device-2 away from the WX Device-1. |
|   | Red   | On       | The signal is too weak. Move the WX Device-2 closer to the WX Device-1.                |

- 10 Now you can connect your WiFi clients to your wireless Mesh network. To do this, note the SSID and WiFi key printed on the side label of the WX Device-1 using this SSID.

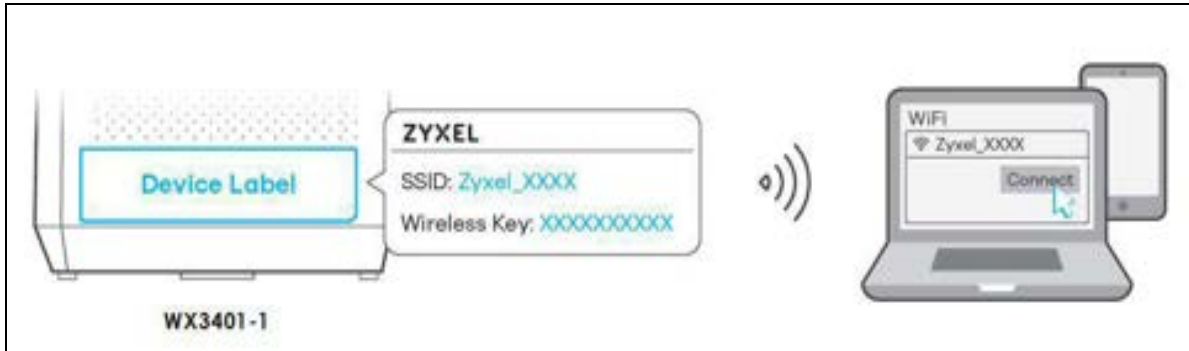

## 4.4 Network Management with the MPro Mesh App

You can manage your controller (the WX Device-1 or a Zyxel MPro Mesh Router) and their WiFi settings through the MPro Mesh app.

Please note that if you are using a WiFi connection with a Zyxel MPro Mesh Router (see [Section 4.3.1 on page 38](#)), you must connect your smartphone to the Zyxel MPro Mesh Router to manage the Mesh network through the app. This is because the Zyxel MPro Mesh Router is the wireless controller.

If you are using a wired connection with a non-MPro Mesh Router (see [Section 4.3.2 on page 43](#)), you must connect your smartphone to the WX Device-1 to manage the Mesh network through the app. This is because the WX Device-1 is the wireless controller.

### 4.4.1 Managing the Controller

Use this screen to view the navigation panel and the status of your WX Device.

Tap on **Home** in the navigation panel to open the following screen.

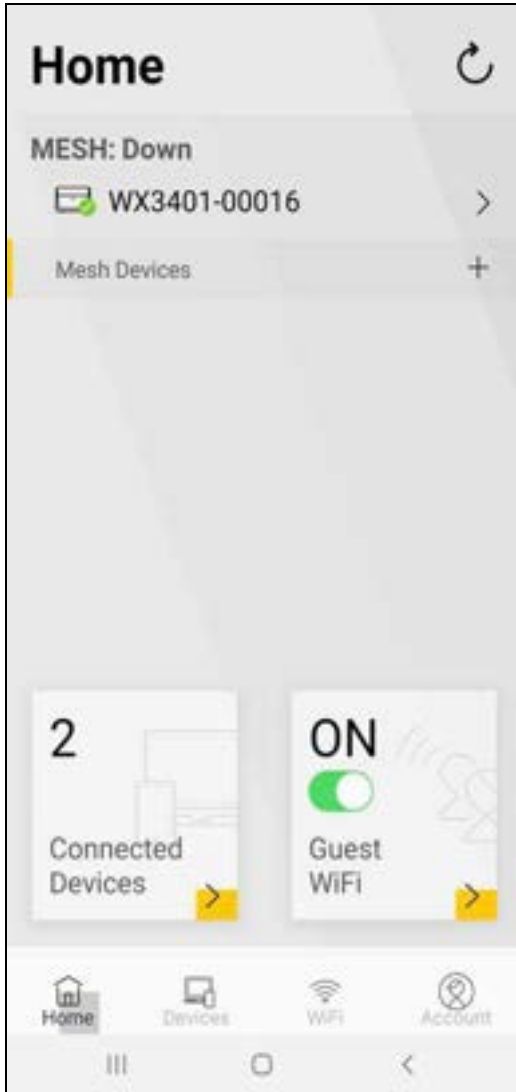

#### 4.4.2 Viewing the Controller Information

Use this screen to view basic information of your controller (the Zyxel MPro Mesh Router or WX Device-1).

Tap on the  icon next to the model name **WX3401-00016** to open the following screen.



Tap on the  icon to change the model name shown on the app.



Tap the  icon to save the changes made. Tap on **Reboot** at the bottom left corner to restart your device.

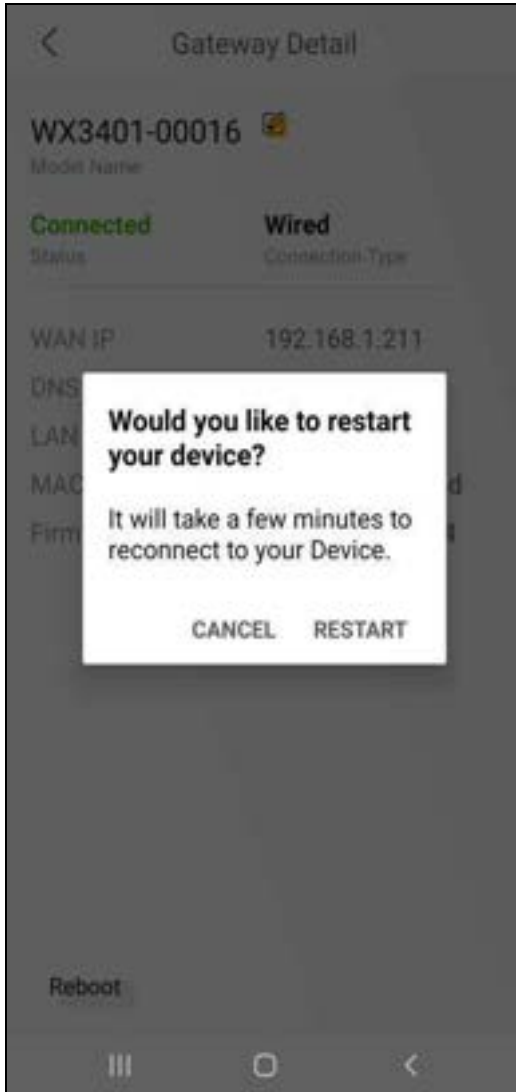

### 4.4.3 Adding Devices to Your Mesh Network

Use this screen to add extenders to your network to form a daisy chain (for more information on daisy chain, see [Section 1.4 on page 16](#)).

On the **Home** screen, tap on the **+** icon to open the following screen.

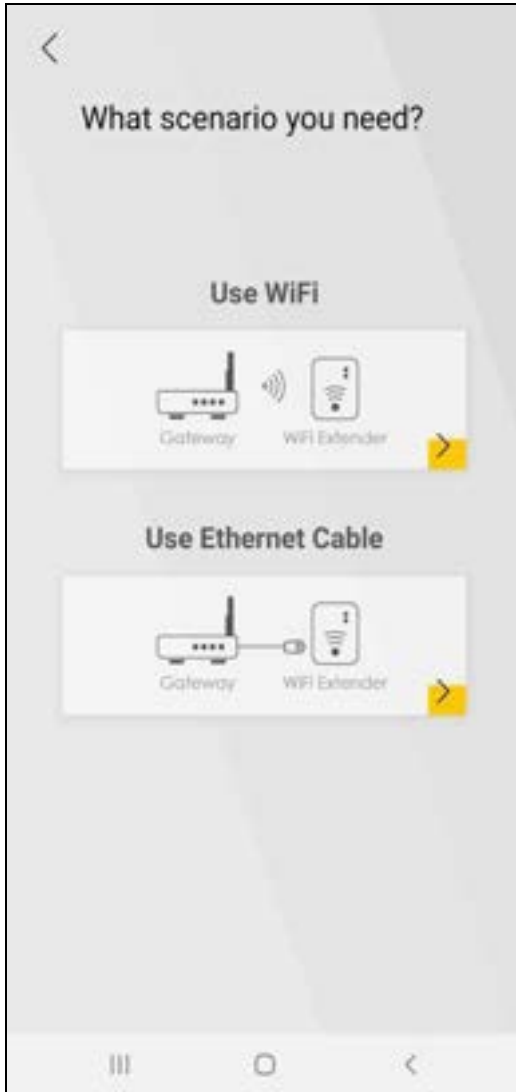

To add a WX Device to your network wirelessly:

- 1 Tap on the  icon under **Use WiFi**.
- 2 The following screen appears. Follow the instruction to set your device to the Repeater mode. Then click **Next** to go to the next step.

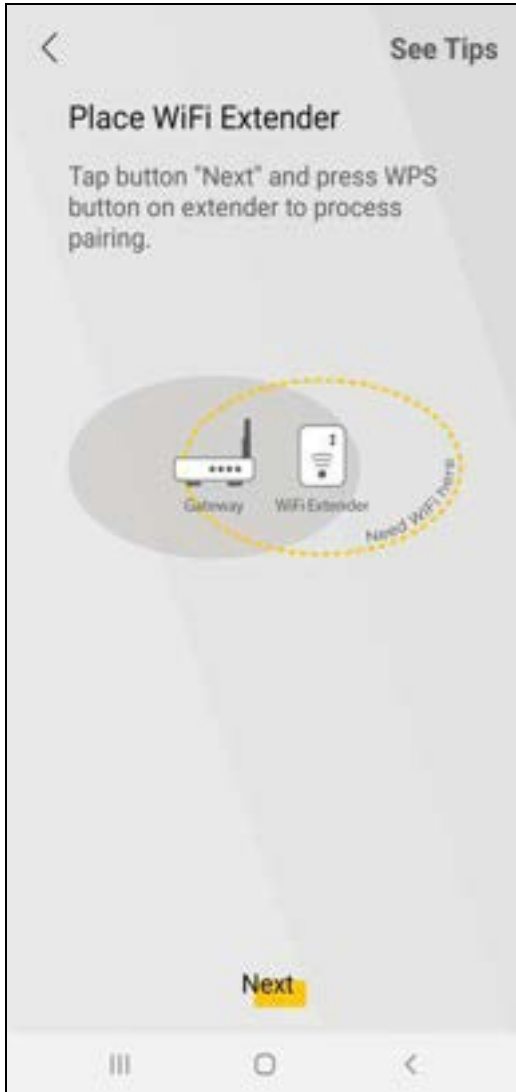

Note: You can tap on **See Tips** on the top right corner to see instruction for finding ideal places to set up your devices.

Note: Your device may not have a mode switch. The method for setting modes for your device may vary depending on the device you use. For WX Device, its mode depends on its uplink connection, see [Section 1.1 on page 11](#) for more information.

- 3 The following screen appears. Follow the instruction and click **Start Pairing** to connect your devices through the WPS button.



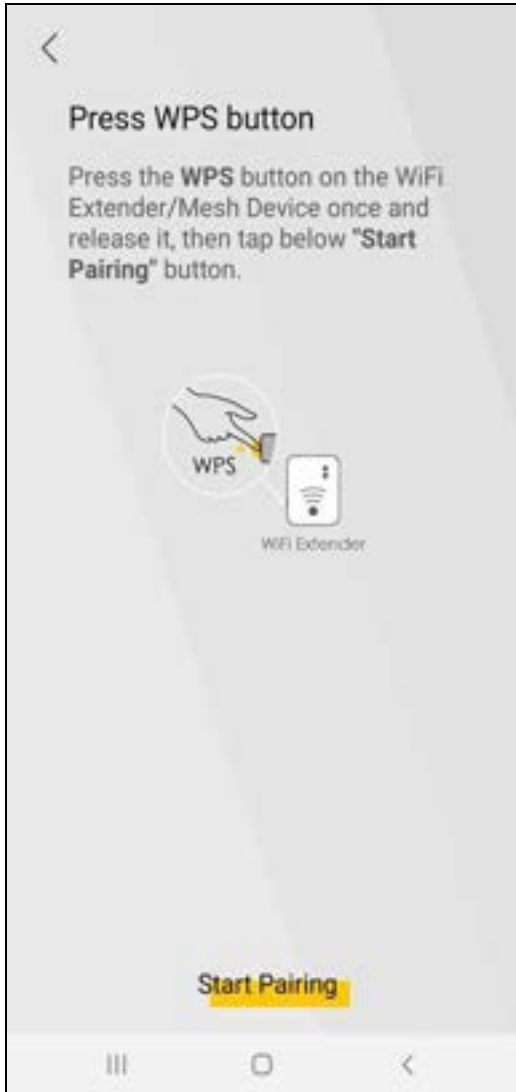

- 4 The following screen appears. Wait for the WX Device to connect to the MPro Mesh Router through the WPS method.

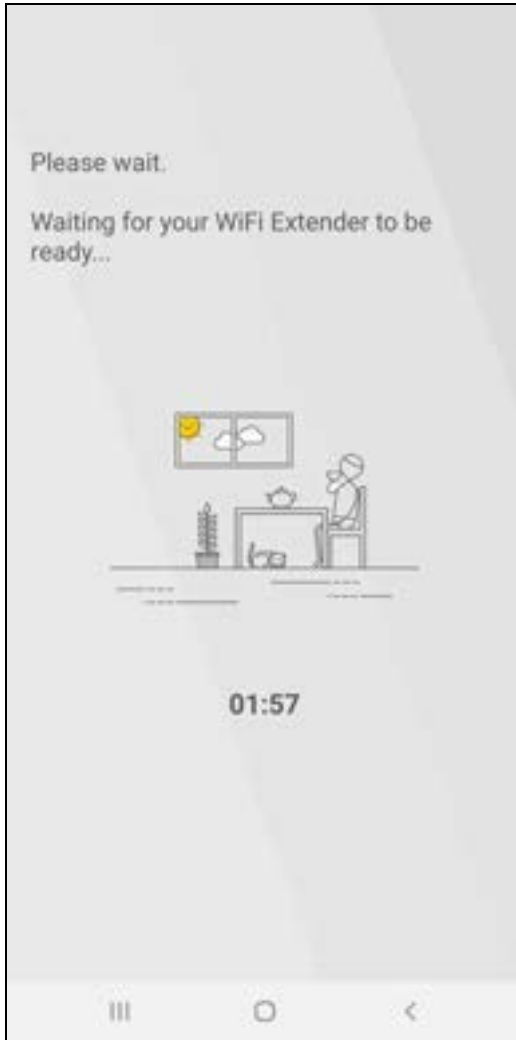

- 5 The following screen appears if the connection fails. Tap on **Need help** to see possible reasons for the connection failure or tap on **Try Again** to try connecting your devices through WPS button once more.

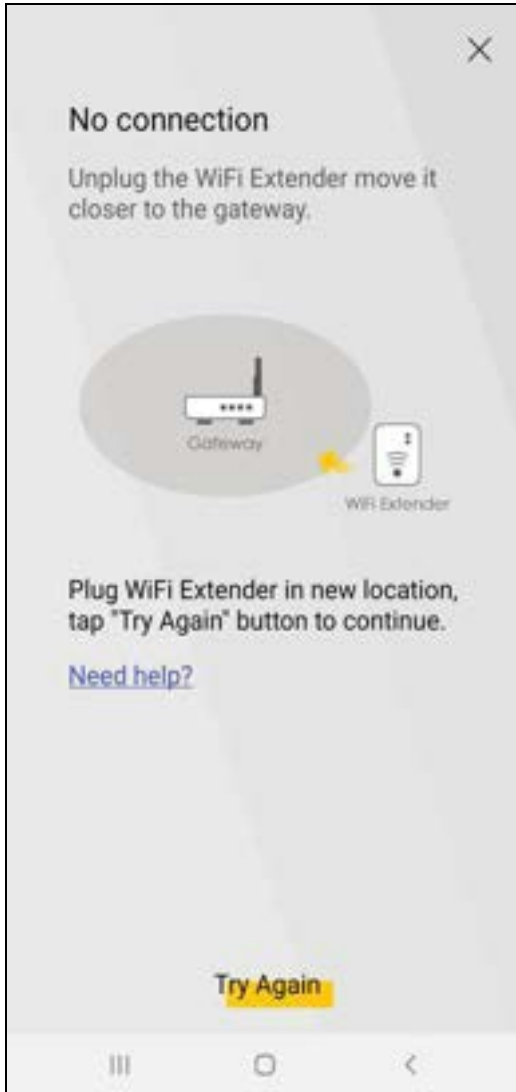

- 6 The following screen appears if the WX Device is connected to the MPro Mesh Router successfully. Tap **Done** to go back to the home screen.



#### 4.4.4 Adding Devices to Your Mesh Network

Use this screen to add extenders or APs to your network to form a daisy chain. On the **Home** screen, tap on the **+** icon to open the following screen.



To add a WX Device to your network with an Ethernet cable:

- 1 Tap on the  icon under **Use Ethernet Cable**.
- 2 The following screen shows. Follow the instruction to set your device to the AP mode. Then click **Done** to go back to the Home page.

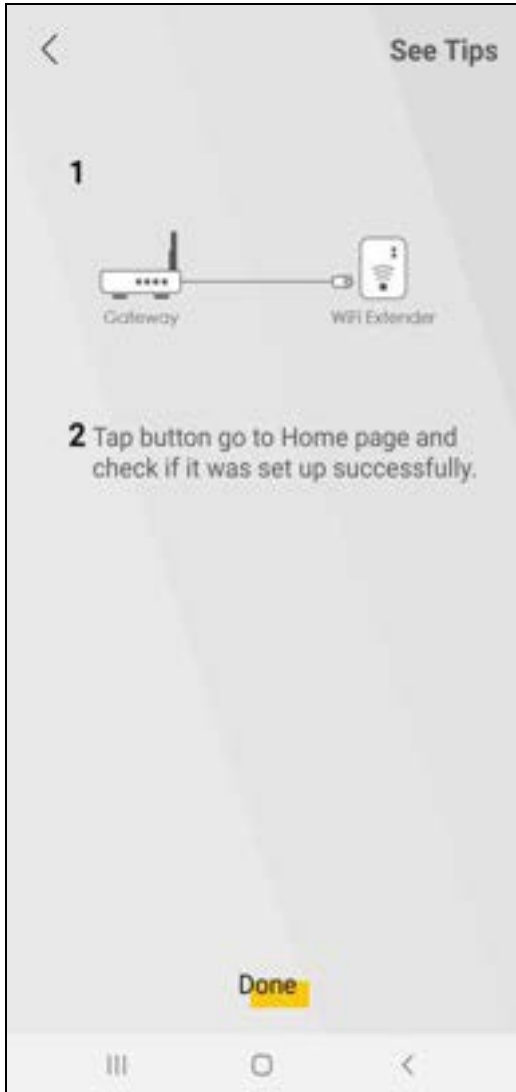

## 4.5 Devices Screen

Use this screen to view clients that are connected to the WX Device and their link quality. You can tap on the search icon  to search for a certain client.

Tap on **Devices** in the navigation panel to open the following screen.



### 4.5.1 Viewing Device Information

Use this screen to view basic information of the client connected to the WX Device and block Internet access to it.

Tap on the  icon to open the following screen.



Tap on the  icon to change the name of your device shown on the app.

## 4.6 WiFi Settings Screen

Use this screen to configure settings for your WiFi network. For more information on Guest WiFi, see [Section 4.7 on page 67](#).

Tap on **WiFi** in the navigation panel to open the following screen.



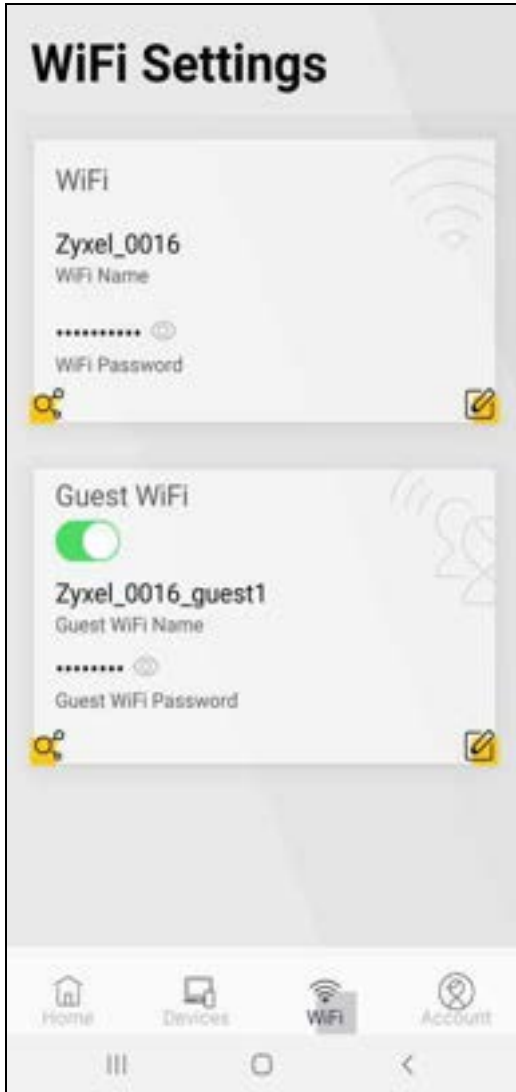

Tap on the  icon to show the QR code for connecting a WiFi client to the WX Device.



### 4.6.1 Editing WiFi Settings

Use this screen to edit the SSID (WiFi name) and password for your WiFi network.

Tap on the  icon to open the following screen.

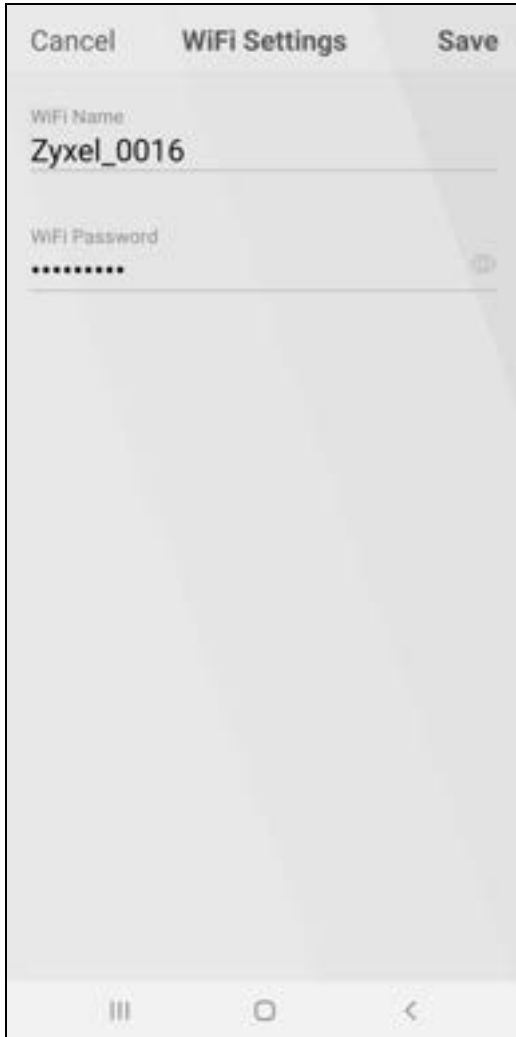

Tap on **Save** to save your changes, or tap on **Cancel** to go back to the previous screen.

## 4.7 Guest WiFi Settings Screen

Use this screen to configure Guest WiFi settings. Slide the Guest WiFi switch to the right  to enable Guest WiFi.

Tap on the  icon and the following screen appears.



### 4.7.1 Editing Guest WiFi Settings

Use this screen to edit the SSID (WiFi Guest name) and password for your WiFi network.

Tap on the  icon to open the following screen.

Note: If you disable Guest WiFi, you must reconnect to the controller.



Tap on **Save** to save your changes, or tap on **Cancel** to go back to the previous screen.

## 4.8 Account Screen

Use this screen to logout or view the app version and privacy policy.

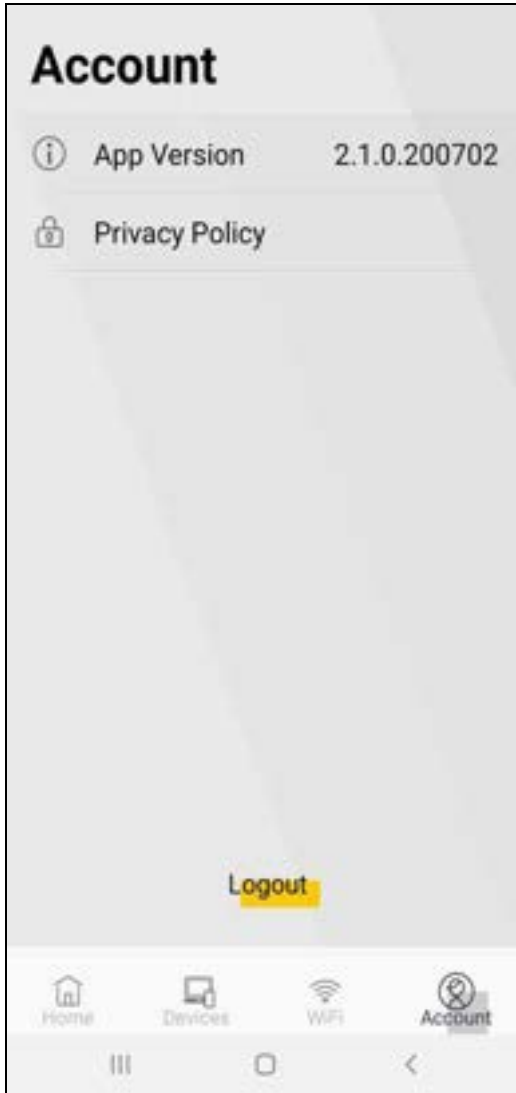

# CHAPTER 5

## Web Tutorials

### 5.1 Overview

This chapter provides web configurator tutorials for setting up a secure WiFi network for your WX Device.

- [WiFi Network Setup](#)
- [Device Maintenance](#)

### 5.2 WiFi Network Setup

Thomas wants to set up a WiFi network so that he can use his notebook to access the Internet. In this WiFi network, the WX Device serves as an access point (AP), and the notebook is the WiFi client. The WiFi client can access the Internet through the AP.



Thomas has to configure the WiFi network settings on the WX Device. Then he can set up a WiFi network using WPS ([Section 5.2.2 on page 73](#)) or manual configuration ([Section 5.2.3 on page 74](#)).

#### 5.2.1 Setting Up a WiFi Network

This example uses the following parameters to set up a WiFi network.

|                |                             |
|----------------|-----------------------------|
| SSID           | Example                     |
| Security Mode  | WPA2-PSK                    |
| Pre-Shared Key | DoNotStealMyWirelessNetwork |
| 802.11 Mode    | 802.11b/g/n/ax Mixed        |

- 1 Click **Network Setting** > **Wireless** to open the **General** screen. Select **More Secure** as the security level and **WPA2-PSK** as the security mode. Configure the screen using the provided parameters (see [Section 5.2.1 on page 71](#)). Click **Apply**.

**Wireless**

Wireless  Keep the same settings for 2.4G and 5G wireless networks.

**Wireless Network Setup**

Band: 2.4GHz

Wireless:

Channel: Auto Default: 6 / 20 MHz

Bandwidth: 20MHz

Control Sideband: None

**Wireless Network Settings**

Wireless Network Name: Example

Max Clients: 32

Hide SSID !

Multicast Forwarding

**Note**

(1) If you are configuring the Zyxel Device from a computer connected to the wireless LAN and you change the Zyxel Device's SSID, channel or security settings, you will lose your wireless connection when you press **Apply** to confirm. You must then change the wireless settings of your computer to match the Zyxel Device's new settings.

(2) If upstream/downstream bandwidth is empty, the Zyxel Device sets the value automatically. Setting a maximum upstream/downstream bandwidth will significantly decrease wireless performance.

SSID: 8F:0D:47:A3:AD:4E

**Security Level**

No Security More Secure (Recommended)

Security Mode: WPA2-PSK

Generate password automatically

Enter 8-63 ASCII characters or 64 hexadecimal digits (0-9, A-F)...

Password: DoNotReidMyWirelessNetwork !

Strength: Strong

Cancel Apply

- 2 Go to the **Wireless > Others** screen and select **802.11b/g/n/ax Mixed** in the **802.11 Mode** field. Click **Apply**.



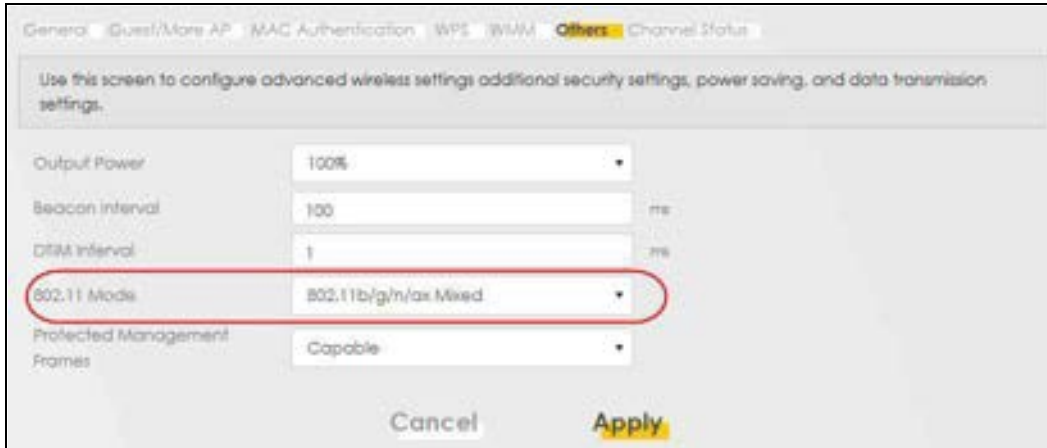

- 3 Thomas can now use the WPS feature to establish a WiFi connection between his notebook and the WX Device (see [Section 5.2.2 on page 73](#)). He can also use the notebook's WiFi client to search for the WX Device (see [Section 5.2.4 on page 74](#)).

## 5.2.2 Setting Up a WiFi Network Using WPS

This section gives you an example of how to set up a WiFi network using WPS. This example uses the WX Device as the AP and a WPS-enabled Android smartphone as the WiFi client.

There are two WPS methods for creating a secure connection. This tutorial shows you how to do both.

- **Push Button Configuration (PBC)** - create a secure WiFi network simply by pressing a button. This is the easier method.
- **PIN Configuration** - create a secure WiFi network simply by entering a WiFi client's PIN (Personal Identification Number) in the WX Device's interface. This is the more secure method, since one device can authenticate the other.

Note: When using WPS in the Web Configurator, and depending on your **Band** selection (**2.4 GHz** or **5 GHz**), the secure connection will apply for the selected **Band** only.

### Push Button Configuration (PBC)

- 1 Make sure that your WX Device is turned on and your notebook is within the cover range of the WiFi signal.
- 2 Push and hold the **WPS** button located on the WX Device's front panel for one second. Alternatively, you may log into the WX Device's Web Configurator and go to the **Network Setting > Wireless > WPS** screen. Enable the WPS function for method 1 and click **Apply**. Then click the **WPS** button.



### 5.2.3 Setting Up a WiFi Network Without WPS

Use the wireless adapter's utility installed on the notebook to search for the "Example" SSID. Then enter the "DoNotStealMyWirelessNetwork" pre-shared key to establish a WiFi Internet connection.

Note: The WX Device supports IEEE 802.11ac/ax WiFi clients. Make sure that your notebook or computer's wireless adapter supports one of these standards.

### 5.2.4 Setting Up WiFi Network Groups

Company A wants to create different WiFi network groups for different types of users as shown in the following figure. Each group has its own SSID and security mode.

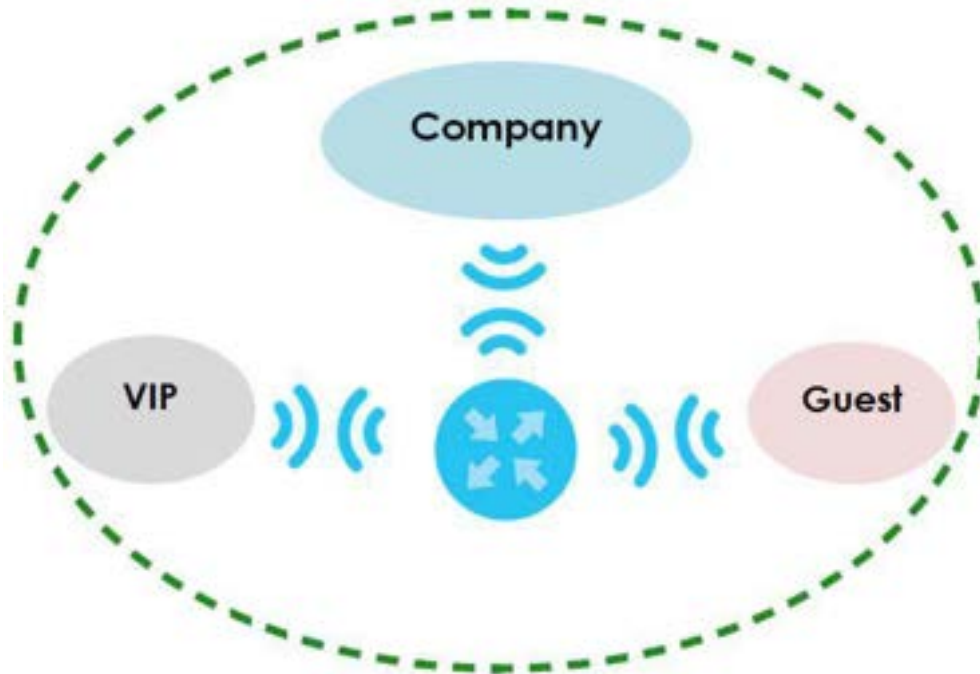

- Employees in Company A will use a general **Company** WiFi network group.
- Higher management level and important visitors will use the **VIP** group.
- Visiting guests will use the **Guest** group, which has a different SSID and password.

Company A will use the following parameters to set up the WiFi network groups.

|                       | COMPANY        | VIP         | GUEST       |
|-----------------------|----------------|-------------|-------------|
| <b>SSID</b>           | Company        | VIP         | Guest       |
| <b>Security Level</b> | More Secure    | More Secure | More Secure |
| <b>Security Mode</b>  | WPA2-PSK       | WPA2-PSK    | WPA2-PSK    |
| <b>Pre-Shared Key</b> | ForCompanyOnly | 123456789   | guest123    |

- 1 Click **Network Setting > Wireless** to open the **General** screen. Use this screen to set up the company's general WiFi network group. Configure the screen using the provided parameters and click **OK**.

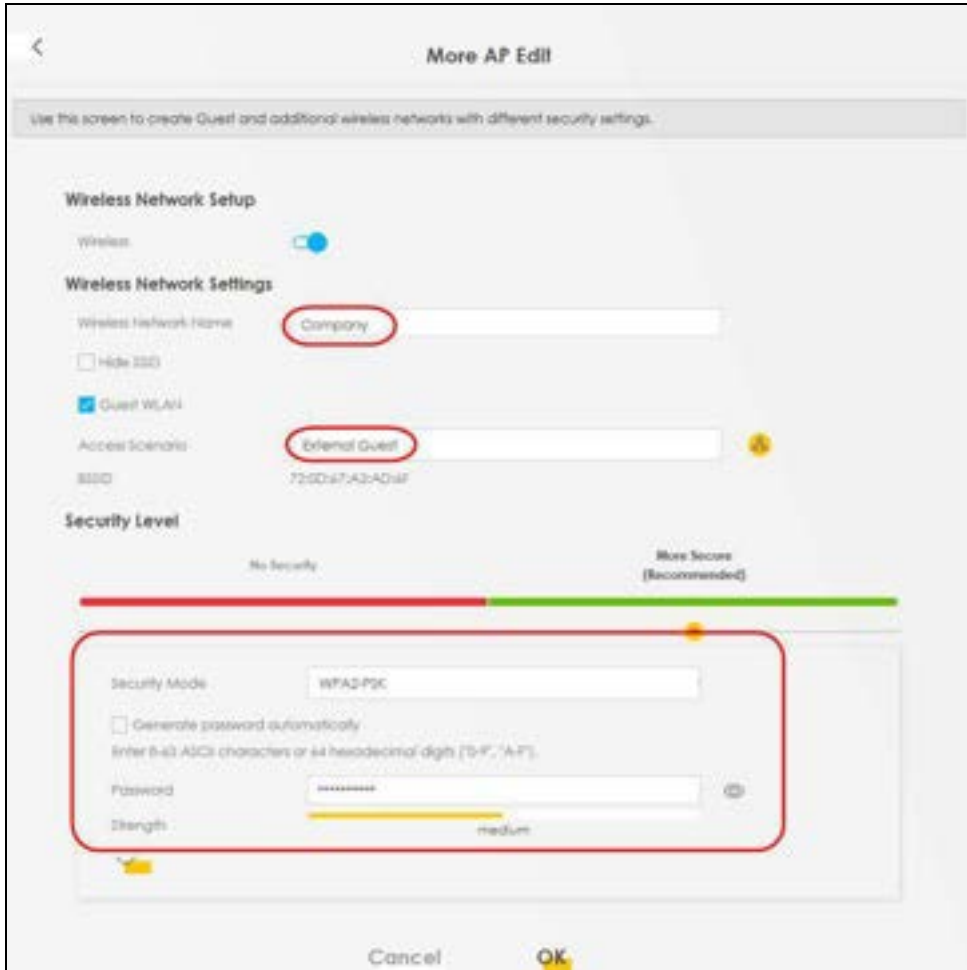

- 2 Click **Network Setting > Wireless > Guest/More AP** to open the following screen. Click the **Modify** icon to configure the second WiFi network group.

| # | Status | SSID    | Security      | Guest WLAN     | Modify |
|---|--------|---------|---------------|----------------|--------|
| 1 | 📶      | Company | WPA2-Personal | External Guest | ⓘ      |
| 2 | 📶      | VP      | WPA2-Personal | External Guest | ⓘ      |
| 3 | 📶      | Guest   | WPA2-Personal | External Guest | ⓘ      |

- 3 Configure the screen using the provided parameters and click **OK**.

The screenshot shows the 'More AP Edit' configuration page. At the top, there is a back arrow and the title 'More AP Edit'. Below the title is a grey bar with the text: 'Use this screen to create Guest and additional wireless networks with different security settings.'

The main configuration area is divided into three sections:

- Wireless Network Setup:** A toggle switch for 'Wireless' is turned on (blue).
- Wireless Network Settings:**
  - 'Wireless Network Name' is set to 'VIP' (circled in red).
  - 'Hide SSID' is unchecked.
  - 'Guest WLAN' is checked (blue).
  - 'Access Scenario' is set to 'External Guest' (circled in red).
  - 'SSID' is '7200a7A3hADu6C'.
- Security Level:** A horizontal bar indicates the security level, ranging from 'No Security' (red) to 'More Secure (Recommended)' (green). The bar is currently positioned towards the 'More Secure' end.

Below the security level bar is a red-bordered box containing the following settings:

- 'Security Mode' is set to 'WPA3-PSE'.
- 'Generate password automatically' is unchecked.
- 'Password' is masked with asterisks.
- 'Strength' is indicated as 'weak'.

At the bottom of the page are 'Cancel' and 'OK' buttons.

Note: The Guest SSID (**Wireless Network Name**) depends on the state of the Main SSID. For example, when the 2.4GHz Main SSID is enabled, then the 2.4GHz Guest SSID can be enabled. But when the 2.4GHz Main SSID is disabled, then the 2.4GHz Guest SSID is automatically disabled (cannot be enabled by the user).

- 4 In the **Guest/More AP** screen, click the **Modify** icon to configure the third WiFi network group. Configure the screen using the provided parameters and click **OK**.

Use this screen to create Guest and additional wireless networks with different security settings.

**Wireless Network Setup**

Wireless

**Wireless Network Settings**

Wireless Network Name

Hide SSID

Guest WLAN

Access Scenario

SSID 720D:e7-A2-AD:eD

**Security Level**

No Security More Secure (Recommended)

Security Mode

Generate password automatically

Enter 8-63 ASCII characters or 64 hexadecimal digits [0-9], [A-F].

Password

Strength  weak

Cancel OK

- 5 Check the status of **VIP** and **Guest** in the **Guest/More AP** screen. The yellow bulbs signify that the SSIDs are active and ready for WiFi access.

| # | Status | SSID    | Security      | Guest WLAN     | Modify |
|---|--------|---------|---------------|----------------|--------|
| 1 |        | Company | WPA2-Personal | External Guest |        |
| 2 |        | VIP     | WPA2-Personal | External Guest |        |
| 3 |        | Guest   | WPA2-Personal | External Guest |        |

### 5.2.5 Connecting to the Zyxel Device's WiFi Network (Windows 10)

This section shows how to set the IP address of a computer using Windows 10 to be in the same subnet as a WX Device.

- 1 In Windows 10, open the **Control Panel**.
- 2 Click **Network and Internet** (this field may be missing in your version) > **Network and Sharing Center**.

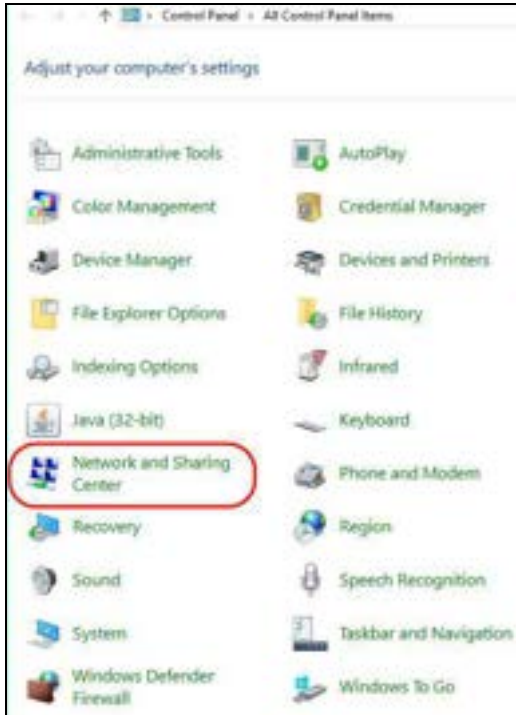

3 Click **Change adapter settings**.

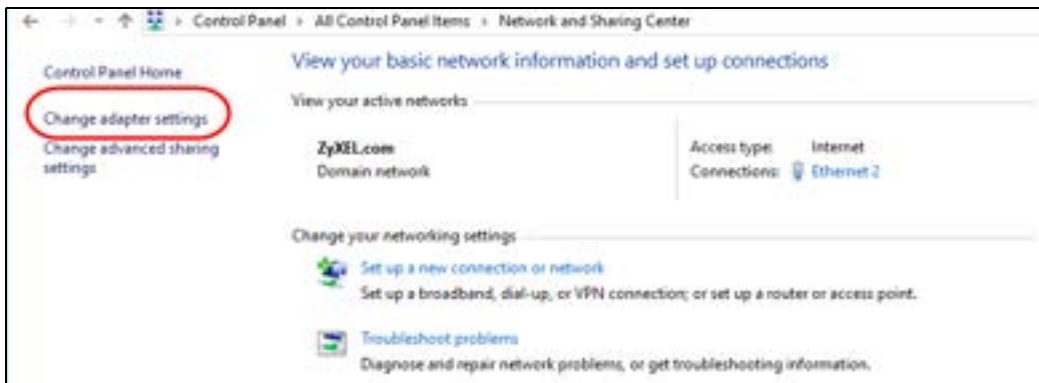

4 Right-click the **Ethernet** icon, and then select **Properties**.

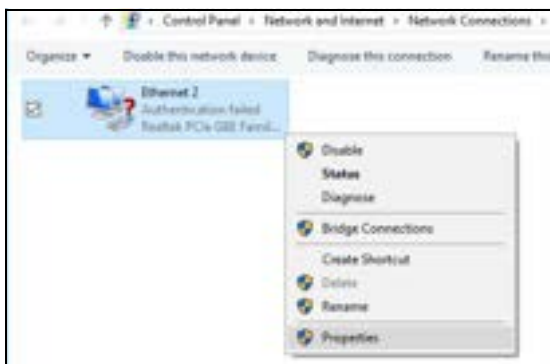

5 Click **Internet Protocol Version 4 (TCP/IPv4)** and then click **Properties**.

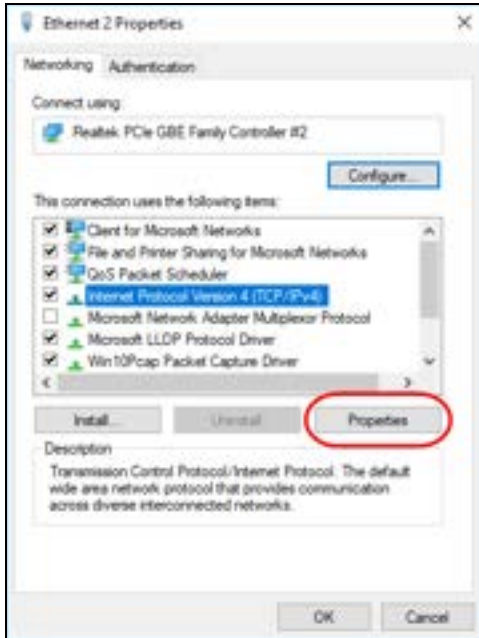

- 6 Select **Use the following IP address** and enter an IP address from 192.168.1.3 to 192.168.1.254. The **Subnet mask** will be entered automatically.



- 7 Click **OK** when you are done and close all windows.

## 5.3 Device Maintenance

### 5.3.1 Upgrading the Firmware

Upload the firmware to the WX Device for feature enhancements.



- 1 Download the firmware file at [www.zyxel.com](http://www.zyxel.com) in a compressed file. Decompress the file.
- 2 Go to the **Maintenance > Firmware Upgrade** screen.
- 3 Click **Browse** and select a .bin file to upload. Click **Upload**.

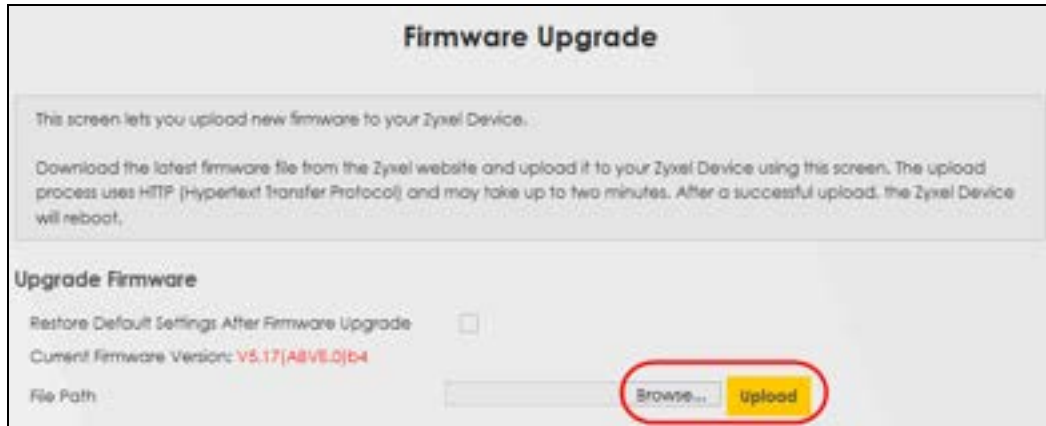

- 4 This process may take up to two minutes to finish. After two minutes, log in again and check your new firmware version in the **Status** screen.

### 5.3.2 Backing up the Device Configuration

Back up a configuration file in case you want to return to your previous settings.

- 1 Go to the **Maintenance > Backup/Restore** screen.
- 2 Click **Backup** in the **Backup Configuration** section, and a configuration file will be saved to your computer.

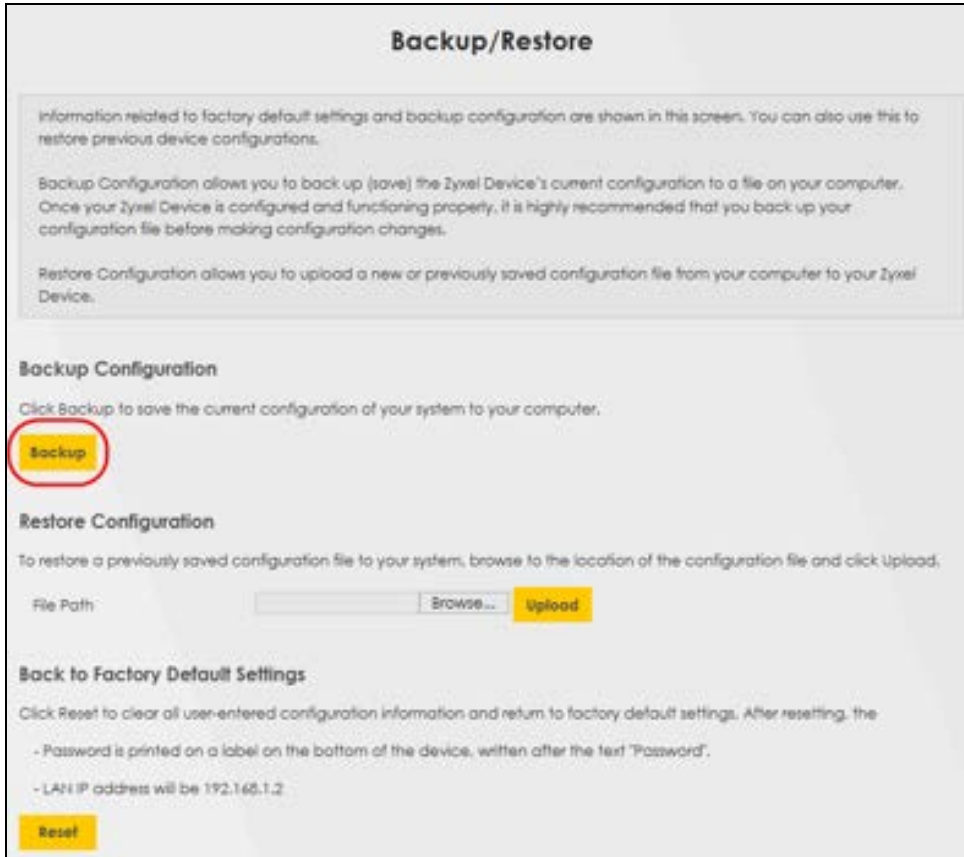

### 5.3.3 Restoring the Device Configuration

You can upload a previously saved configuration file from your computer to your WX Device to restore that previous configuration.

- 1 Go to the **Maintenance > Backup/Restore** screen.
- 2 Click **Browse** in **Restore Configuration** section, and select the configuration file that you want to upload. Click **Upload**.

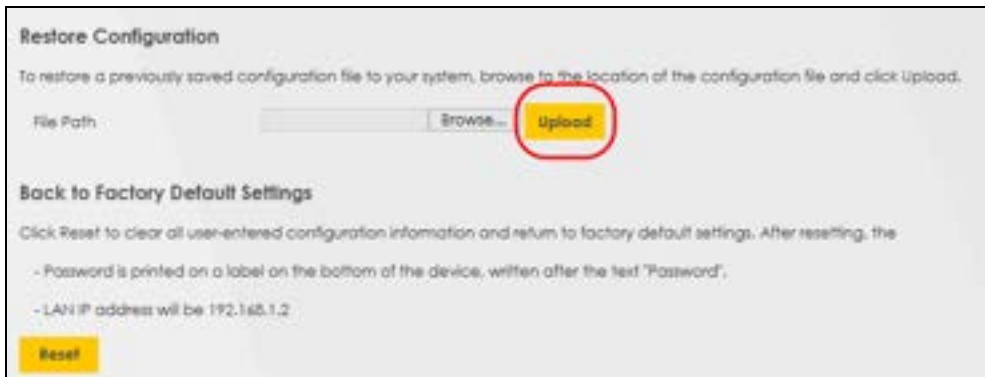

- 3 The WX Device will restart automatically after the configuration file is successfully uploaded. Wait for one minute before logging into the WX Device again.

# CHAPTER 6

## Connection Status



### 6.1 Overview

After you log into the Web Configurator, the **Connection Status** screen appears. You can configure basic Internet access and wireless settings in this screen. It also shows the network status of the WX Device and computers/devices connected to it.

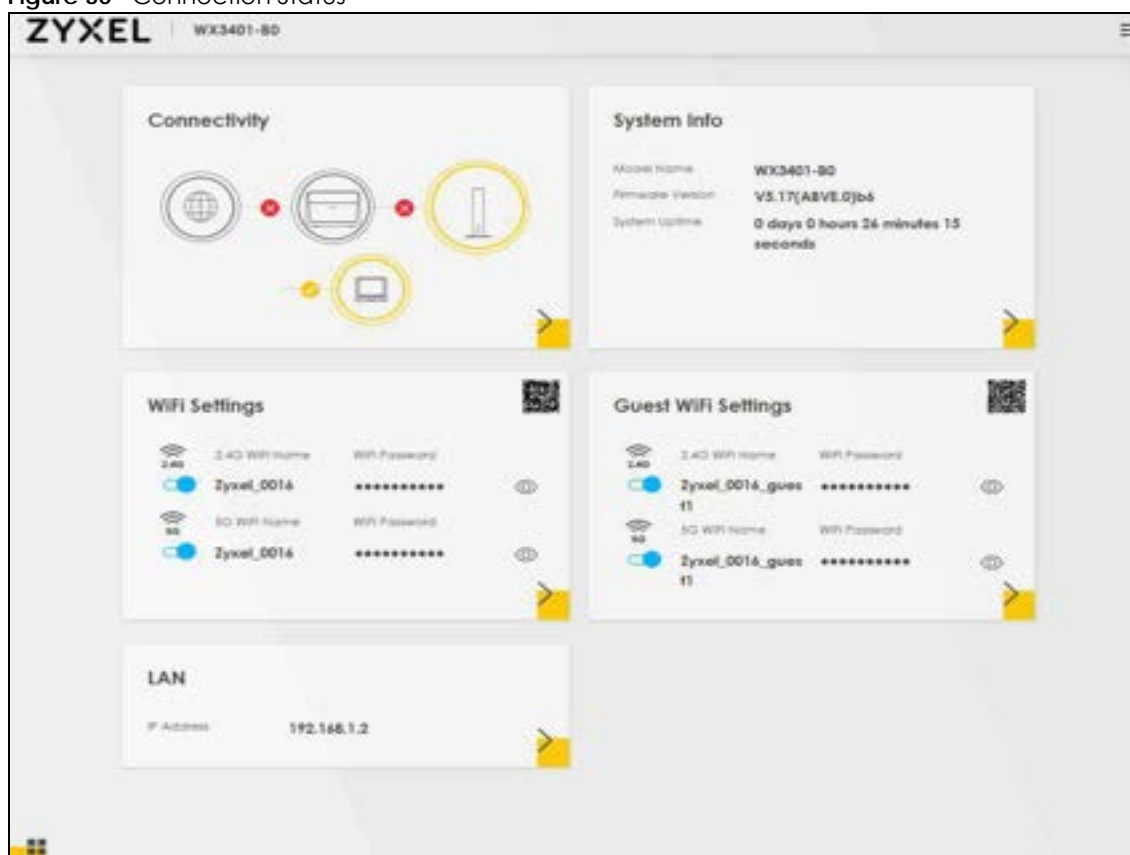
Figure 30 Connection Status



## 6.1.1 Layout Icon

Click this icon (  ) to arrange the screen order. Select a block and hold it to move around. Click the Check icon (  ) in the lower left corner to save the changes.



## 6.1.2 Connectivity

Use this screen to view the network connection status of the WX Device and its clients.

**Figure 31** Connectivity



Click the Arrow icon (  ) to open the following screen. Use this screen to view IP addresses and MAC addresses of the wireless and wired devices connected to the WX Device.

Place your mouse within the device block, and an Edit icon (  ) will appear. Click the Edit icon to change the icon and name of a connected device.

Figure 32 Connectivity: Connected Devices



## Icon and Device Name

You can change the icon and name of a connected device by clicking the device's Edit icon. Select an icon and/or enter a name in the **Device Name** field for a connected device. Click **Save** to save your changes.

Figure 33 Connectivity: Edit



## 6.1.3 System Info

Use this screen to view the basic system information of the WX Device.

Figure 34 System Info

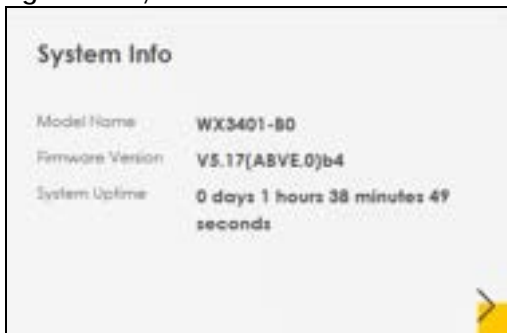

Click the Arrow icon (➤) to open the following screen. Use this screen to view more information on the status of your firewall and interfaces (LAN, and WiFi).

**Figure 35** System Info: Detailed Information



Each field is described in the following table.

**Table 14** System Info: Detailed Information

| LABEL   | DESCRIPTION  |
|---|--|
| Host Name   | This field displays the WX Device system name. It is used for identification.  |
| Model Name  | This shows the model number of your WX Device.   |
| Serial Number   | This field displays the serial number of the WX Device.  |
| Firmware Version  | This is the current version of the firmware on the WX Device.  |
| System Uptime   | This field displays how long the WX Device has been running since it last started up. The WX Device starts up when you plug it in, when you restart it ( <b>Maintenance &gt; Reboot</b> ), or when you reset it. |
| Interface Status  |  |
| Virtual ports are shown here. You can see whether the ports are in use and their transmission rate. |  |
| LAN Information (These fields display information about the LAN ports.)                             |  |
| IP Address  | This is the current IPv4 address of the WX Device in the LAN.  |
| Subnet Mask   | This is the current subnet mask in the LAN.  |
| IPv6 Address  | This is the current IPv6 address of the WX Device in the LAN.  |
| IPv6 Link Local Address   | This field displays the current link-local address of the WX Device for the LAN interface.   |
| MAC Address   | This field displays the LAN Ethernet adapter MAC (Media Access Control) address of your WX Device.   |
| WLAN Information 2.4 G/5 G  |  |

Table 14 System Info: Detailed Information (continued)

| LABEL       | DESCRIPTION   |
|-------------|---|
| MAC Address | This shows the wireless adapter MAC (Media Access Control) address of the wireless interface. |
| Status      | This displays whether WiFi is activated.  |
| SSID        | This is the descriptive name used to identify the WX Device in a wireless LAN.                |
| Channel     | This is the channel number used by the wireless interface now.                                |
| Security    | This displays the type of security mode the wireless interface is using in the wireless LAN.  |
| 802.11 Mode | This displays the type of 802.11 mode the wireless interface is using in the wireless LAN.    |
| WPS         | This displays whether WPS is activated on the wireless interface.                             |

## 6.2 WiFi Settings



Use this screen to configure the main 2.4G and/or 5G wireless network settings. When the switch goes to the right (  ), the function is enabled. Otherwise, it is not. You can use this screen or the QR code on the upper right corner to check the SSIDs (WiFi network name) and passwords of the main wireless networks. If you want to show or hide your WiFi passwords, click the Eye icon (  ).

Figure 36 WiFi Settings







Click the Arrow icon (  ) to open the following screen. Use this screen to configure the SSIDs and/or passwords for your main wireless networks. When the switch goes to the right (  ), the function is enabled. Otherwise, it is not. Select **Keep 2.4G and 5G the same** to use the same SSID for 2.4 GHz and 5 GHz bands.

Figure 37 WiFi Settings: Configuration



Each field is described in the following table.

Table 15 WiFi Settings: Configuration

| LABEL                     | DESCRIPTION  |
|---------------------------|--|
| Keep 2.4G and 5G the same | Select this and the 2.4G and 5G wireless networks will use the same SSID.<br>If you deselect this, the screen will change. You need to assign different SSIDs for the 2.4G and 5G wireless networks.   |
| 2.4G/5G WiFi              | Click this switch to enable or disable the 2.4G and/or 5G wireless networks. When the switch goes to the right (  ), the function is enabled. Otherwise, it is not.              |
| WiFi Name                 | The SSID (Service Set IDentity) identifies the service set with which a wireless device is associated. Wireless devices associating to the access point (AP) must have the same SSID.<br>Enter a descriptive name (up to 32 English keyboard characters) for WiFi. |
| WiFi Password             | If you selected <b>Random Password</b> , this field displays a pre-shared key generated by the WX Device.<br>If you did not select <b>Random Password</b> , you can manually type a pre-shared key from 8 to 64 case-sensitive keyboard characters.                |
|                           | Click the Eye icon to show or hide the password for your wireless network. When the Eye icon is slashed  , you'll see the password in plain text. Otherwise, it is hidden.      |
| Random Password           | Select this option to have the WX Device automatically generate a password. The <b>WiFi Password</b> field will not be configurable when you select this option.   |
| Hide WiFi Name            | Select this check box to hide the SSID in the outgoing beacon frame so a station cannot obtain the SSID through scanning using a site survey tool.<br><br>Note: Disable WPS in the <b>Network Setting &gt; Wireless &gt; WPS</b> screen to hide the SSID.          |
| Save                      | Click <b>Save</b> to save your changes.  |

## 6.3 Guest WiFi Settings

Use this screen to enable or disable the guest 2.4G and/or 5G wireless networks. When the switch goes to the right (  ), the function is enabled. Otherwise, it is not. You can check their SSIDs (WiFi network name) and passwords from this screen. If you want to show or hide your WiFi passwords, click the Eye icon.



Figure 38 Guest WiFi Settings



Click the Arrow icon (➤) to open the following screen. Use this screen to configure the 2.4G and 5G SSIDs and/or passwords for your guest wireless networks.

Figure 39 Guest WiFi Settings: Configuration





To assign different SSIDs to the 2.4G and 5G guest wireless networks, clear the **Keep 2.4G and 5G the same** check box in the **WiFi Settings** screen, and the **Guest WiFi Settings** screen will change.

Figure 40 Guest WiFi Settings: Different SSIDs



Each field is described in the following table.

Table 16 WiFi Settings: Configuration

| LABEL                | DESCRIPTION  |
|----------------------|--|
| WiFi<br>2.4G/5G WiFi | Click this switch to enable or disable the 2.4G and/or 5G wireless networks. When the switch goes to the right  , the function is enabled. Otherwise, it is not.                  |
| WiFi Name            | The SSID (Service Set IDentity) identifies the service set with which a wireless device is associated. Wireless devices associating to the access point (AP) must have the same SSID.<br>Enter a descriptive name (up to 32 English keyboard characters) for WiFi. |
| WiFi Password        | If you selected <b>Random Password</b> , this field displays a pre-shared key generated by the WX Device.<br>If you did not select <b>Random Password</b> , you can manually type a pre-shared key from 8 to 64 case-sensitive keyboard characters.                |
|                      | Click the Eye icon to show or hide the password of your wireless network. When the Eye icon is slashed  , you'll see the password in plain text. Otherwise, it is hidden.         |
| Random Password      | Select this option to have the WX Device automatically generate a password. The <b>WiFi Password</b> field will not be configurable when you select this option.   |
| Hide WiFi Name       | Select this check box to hide the SSID in the outgoing beacon frame so a station cannot obtain the SSID through scanning using a site survey tool.<br><br>Note: Disable WPS in the <b>Network Setting &gt; Wireless &gt; WPS</b> screen to hide the SSID.          |
| Save                 | Click <b>Save</b> to save your changes.  |

## 6.4 LAN Settings

Use this screen to view the LAN IP address and subnet mask of your WX Device.

Figure 41 LAN



Click the Arrow icon () to open the following screen. Use this screen to configure the LAN IP address and subnet mask for your WX Device.

Figure 42 LAN Setup

The screenshot shows a mobile interface for LAN setup. At the top, there is a back arrow and the title 'LAN'. Below that is a sub-header 'LAN IP Setup'. There are two input fields: 'IP Address' with the value '192.168.1.2' and 'Subnet Mask' with the value '255.255.255.0'. At the bottom center, there is a yellow 'Save' button.

Each field is described in the following table.

Table 17 Status Screen

| LABEL        | DESCRIPTION  |
|--------------|--|
| LAN IP Setup |  |
| IP Address   | Enter the LAN IPv4 address you want to assign to your WX Device in dotted decimal notation, for example, 192.168.1.2 (factory default).  |
| Subnet Mask  | Type the subnet mask of your network in dotted decimal notation, for example 255.255.255.0 (factory default). Your WX Device automatically computes the subnet mask based on the IP address you enter, so do not change this field unless you are instructed to do so. |
| Save         | Click <b>Save</b> to save your changes.  |

# CHAPTER 7

## Wireless

### 7.1 Wireless Overview

This chapter describes the WX Device's **Network Setting > Wireless** screens. Use these screens to set up your WX Device's WiFi connection and security settings.

#### 7.1.1 What You Can Do in this Chapter

This section describes the WX Device's **Wireless** screens. Use these screens to set up your WX Device's wireless connection.

- Use the **General** screen to enable WiFi, enter the SSID and select the wireless security mode ([Section 7.2 on page 93](#)).
- Use the **Guest/More AP** screen to set up multiple wireless networks on your WX Device ([Section 7.3 on page 98](#)).
- Use the **MAC Authentication** screen to allow or deny wireless clients based on their MAC addresses from connecting to the WX Device ([Section 7.4 on page 100](#)).
- Use the **WPS** screen to enable or disable WPS, view or generate a security PIN (Personal Identification Number) ([Section 7.5 on page 102](#)).
- Use the **WMM** screen to enable WiFi MultiMedia (WMM) to ensure quality of service in wireless networks for multimedia applications ([Section 7.6 on page 104](#)).
- Use the **Others** screen to configure wireless advanced features, such as the DTIM interval ([Section 7.7 on page 105](#)).
- Use the **Channel Status** screen to scan WiFi channel noises and view the results ([Section 7.8 on page 107](#)).
- Use the **Operating Modes** screen to manually enter the SSID and security settings of the AP to which you want the WX Device to connect ([Section 7.9 on page 108](#)).
- Use the **AP List** screen to scan the wireless networks in the WX Device's area. You can also select an AP from the list and enter its WiFi password to connect to the wireless network ([Section 7.10 on page 110](#)).

#### 7.1.2 What You Need to Know

##### Wireless Basics

"Wireless" is essentially radio communication. In the same way that walkie-talkie radios send and receive information over the airwaves, wireless networking devices exchange information with one another. A wireless networking device is just like a radio that lets your computer exchange information with radios attached to other computers. Like walkie-talkies, most wireless networking devices operate at radio frequency bands that are open to the public and do not require a license to use. However, wireless networking is different from that of most traditional radio communications in that there are a number of wireless networking standards available with different methods of data encryption.

## WiFi6 / IEEE 802.11ax

WiFi6 is backwards compatible with IEEE 802.11a/b/g/n/ac and is most suitable in areas with a high concentration of users. WiFi6 devices support Target Wakeup Time (TWT) allowing them to automatically power down when they are inactive.

The following table displays the comparison of the different WiFi standards.

| WIFI STANDARD | MAXIMUM LINK RATE * | BAND              | SIMULTANEOUS CONNECTIONS |
|---------------|---------------------|-------------------|--------------------------|
| 802.11b       | 11 Mbps             | 2.4 GHz           | 1                        |
| 802.11a/g     | 54 Mbps             | 2.4 GHz and 5 GHz | 1                        |
| 802.11n       | 600 Mbps            | 2.4 GHz and 5 GHz | 1                        |
| 802.11ac      | 6.93 Gbps           | 5 GHz             | 4                        |
| 802.11ax      | 2.4 Gbps            | 2.4 GHz           | 128                      |
|               | 9.61 Gbps           | 5 GHz and 6 GHz   |                          |

\* The maximum link rate is for reference under ideal conditions only.

## 7.2 Wireless General Settings

Use this screen to enable WiFi, enter the SSID and select the wireless security mode. These are basic elements for starting a wireless service. It's recommended that you select **More Secure** to enable **WPA2-PSK** data encryption.

Note: If you are configuring the WX Device from a computer connected to WiFi and you change the WX Device's SSID, channel or security settings, you will lose your wireless connection when you press **Apply** to confirm. You must then change the wireless settings of your computer to match the WX Device's new settings.

Click **Network Setting > Wireless** to open the **General** screen.

Figure 43 Network Setting &gt; Wireless &gt; General

The screenshot shows the 'General' tab of the 'Wireless' settings. At the top, there are tabs for 'General', 'Guest/More AP', 'MAC Authentication', 'WPS', 'WMM', 'Others', and 'Channel Info'. A note at the top states: 'Use this screen to enable the Wireless LAN, enter the SSID and select the wireless security mode. These are basic elements for starting a wireless service. It's recommended that you select **More Secure** to enable WPA2-PSK data encryption.'

**Wireless**

Keep the same settings for 2.4G and 5G wireless networks

**Wireless Network Setup**

Band: 2.4GHz

Wireless:  (Switch is blue)

Channel: Auto (Current: 14 / 23MHz)

Bandwidth: 20MHz

Control Selection: Lower

**Wireless Network Settings**

Wireless Network Name: Zyxel\_2014

Max Clients: 32

Hide SSID

Multicast Forwarding

**Note**

If you are configuring the Zyxel Device from a computer connected by WiFi and you change the Zyxel Device's SSID, channel or security settings, you will lose your WiFi connection when you press **Apply**. You must change the WiFi settings of your computer to match the new settings on the Zyxel Device.

SSID: WOODK7-A2AD4E

**Security Level**

Security Level: A slider bar between 'No Security' and 'More Secure (Recommended)'. The slider is positioned towards 'More Secure'.

Security Mode: WPA2-PSK

Generate password automatically

Enter 8-62 ASCII characters or 81 hexadecimal digits [0-F, A-F].

Password: [Redacted]

Strength: [Redacted]

Buttons: Cancel, Apply

The following table describes the general WiFi labels in this screen.

Table 18 Network Setting &gt; Wireless &gt; General

| LABEL                  | DESCRIPTION   |
|------------------------|---|
| Wireless               |   |
| Wireless               | Select <b>Keep the same settings for 2.4G and 5G wireless networks</b> and the 2.4 GHz and 5 GHz wireless networks will use the same SSID and wireless security settings.   |
| Wireless Network Setup |   |
| Band                   | This shows the wireless band which this radio profile is using. <b>2.4GHz</b> is the frequency used by IEEE 802.11b/g/n/ax wireless clients while <b>5GHz</b> is used by IEEE 802.11a/n/ac/ax wireless clients.<br><br>Note: The <b>Operating Modes</b> and <b>AP List</b> screen are only available if you select the <b>5GHz Band</b> . |
| Wireless               | Click this switch to enable or disable WiFi in this field. When the switch turns blue <input checked="" type="checkbox"/> , the function is enabled. Otherwise, it is not.  |
| Channel                | Select a channel from the drop-down list box. The options vary depending on the frequency band and the country you are in.<br><br>Use <b>Auto</b> to have the WX Device automatically determine a channel to use.   |

Table 18 Network Setting &gt; Wireless &gt; General (continued)

| LABEL                     | DESCRIPTION   |
|---------------------------|---|
| Bandwidth                 | <p>Select whether the WX Device uses a wireless channel width of <b>20MHz</b>, <b>40MHz</b>, <b>20/40MHz</b>, <b>20/40/80MHz</b>, or <b>20/40/80/160MHz</b>.</p> <p>A standard 20MHz channel offers transfer speeds of up to 150Mbps whereas a 40MHz channel uses two standard channels and offers speeds of up to 300 Mbps.</p> <p>40 MHz (channel bonding or dual channel) bonds two adjacent radio channels to increase throughput. A 80 MHz channel consists of two adjacent 40 MHz channels. The wireless clients must also support 40 MHz or 80 MHz. It is often better to use the 20 MHz setting in a location where the environment hinders the wireless signal.</p> <p>A standard 20 MHz channel offers transfer speeds of up to 150 Mbps whereas a 40 MHz channel uses two standard channels and offers speeds of up to 300 Mbps.</p> <p>40 MHz (channel bonding or dual channel) bonds two adjacent radio channels to increase throughput. The wireless clients must also support 40 MHz. It is often better to use the 20 MHz setting in a location where the environment hinders the wireless signal.</p> <p>An 80 MHz channel groups adjacent 40 MHz channels into pairs to increase bandwidth even higher.</p> <p>Select <b>20MHz</b> if you want to lessen radio interference with other wireless devices in your neighborhood or the wireless clients do not support channel bonding.</p> <p>Because not all devices support 40 MHz channels, select <b>20MHz</b> or <b>20/40MHz</b> to allow the WX Device to adjust the channel bandwidth.</p> |
| Control Sideband          | This is available for some regions when you select a specific channel and set the <b>Bandwidth</b> field to <b>40MHz</b> or <b>20/40MHz</b> . Set whether the control channel (set in the <b>Channel</b> field) should be in the <b>Lower</b> or <b>Upper</b> range of channel bands.   |
| Wireless Network Settings |   |
| Wireless Network Name     | <p>The SSID (Service Set IDentity) identifies the service set with which a wireless device is associated. Wireless devices associating to the access point (AP) must have the same SSID.</p> <p>Enter a descriptive name (up to 32 English keyboard characters) for WiFi.</p>   |
| Max Clients               | Specify the maximum number of clients that can connect to this network at the same time.  |
| Hide SSID                 | <p>Select this check box to hide the SSID in the outgoing beacon frame so a station cannot obtain the SSID through scanning using a site survey tool.</p> <p>This check box is grayed out if the WPS function is enabled in the <b>Network Setting &gt; Wireless &gt; WPS</b> screen.</p>   |
| Multicast Forwarding      | Select this check box to allow the WX Device to convert wireless multicast traffic into wireless unicast traffic.   |
| BSSID                     | This shows the MAC address of the wireless interface on the WX Device when WiFi is enabled.   |
| Security Level            |   |
| Security Mode             | <p>Select <b>More Secure (Recommended)</b> to add security on this wireless network. The wireless clients which want to associate to this network must have same wireless security settings as the WX Device. When you select to use a security, additional options appears in this screen.</p> <p>Or you can select <b>No Security</b> to allow any client to associate this network without any data encryption or authentication.</p> <p>See the following sections for more details about this field.</p>   |
| Cancel                    | Click <b>Cancel</b> to restore the default or previously saved settings.  |
| Apply                     | Click <b>Apply</b> to save your changes.  |

## 7.2.1 No Security

Select **No Security** to allow wireless stations to communicate with the WX Device without any data encryption or authentication.

Note: If you do not enable any wireless security on your WX Device, your network is accessible to any wireless networking device that is within range.

**Figure 44** Wireless > General: No Security

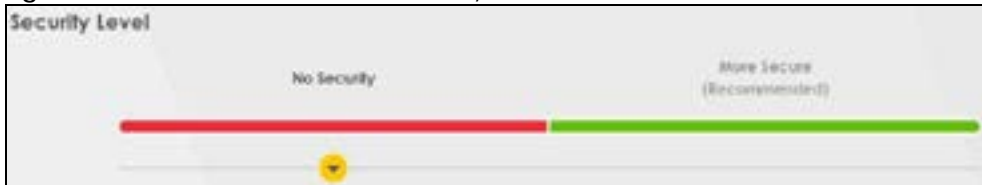

The following table describes the labels in this screen.

Table 19 Wireless > General: No Security

| LABEL          | DESCRIPTION  |
|----------------|--|
| Security Level | Choose <b>No Security</b> to allow all wireless connections without data encryption or authentication. |

## 7.2.2 More Secure (Recommended)

The WPA-PSK security mode provides both improved data encryption and user authentication over WEP. Using a Pre-Shared Key (PSK), both the WX Device and the connecting client share a common password in order to validate the connection. This type of encryption, while robust, is not as strong as WPA, WPA2 or even WPA2-PSK. The WPA2-PSK security mode is a newer, more robust version of the WPA encryption standard. It offers slightly better security, although the use of PSK makes it less robust than it could be.

Click **Network Setting > Wireless** to display the **General** screen. Select **More Secure** as the security level. Then select **WPA2-PSK**, **WPA3-SAE** or **WPA3-SAE/WPA2-PSK** from the **Security Mode** list.





Figure 45 Wireless &gt; General: More Secure: WPA2-PSK

The screenshot shows a configuration window for wireless security. At the top, there's a 'Security Level' section with a slider between 'No Security' and 'More Secure (Recommended)'. The 'More Secure' option is selected. Below this, the 'Security Mode' dropdown is set to 'WPA2-PSK'. A checkbox for 'Generate password automatically' is checked. A text prompt asks to 'Enter 8-63 ASCII characters or 64 hexadecimal digits (0-9, A-F)'. The 'Password' field is empty, and the 'Strength' indicator shows 'weak'. The 'Encryption' dropdown is set to 'AES', and the 'Timer' is set to '3600 sec'. At the bottom, there are 'Cancel' and 'Apply' buttons.

The following table describes the labels in this screen.

Table 20 Wireless &gt; General: More Secure: WPA2-PSK

| LABEL                           | DESCRIPTION  |
|---------------------------------|--|
| Security Level                  | Select <b>More Secure</b> to enable WPA2-PSK data encryption.  |
| Security Mode                   | Select the data encryption method the WX Device uses.<br>Select <b>WPA2-PSK</b> , <b>WPA3-SAE</b> or <b>WPA3-SAE/WPA2-PSK</b> to add security on this wireless network. The wireless clients which want to associate to this network must have same wireless security settings as this device. Or you can select <b>No Security</b> to allow any client to associate this network without authentication.  |
| Generate password automatically | Select this option to have the WX Device automatically generate a password. The password field will not be configurable when you select this option.   |
| Password                        | Select <b>Generate password automatically</b> or enter a <b>Password</b> .<br>The password has two uses.<br><ol style="list-style-type: none"> <li>1. Manual. Manually enter the same password on the WX Device and the client. Enter 8-63 ASCII characters or exactly 64 hexadecimal ('0-9', 'a-f') characters.</li> <li>2. WPS. When using WPS, the WX Device sends this password to the client.</li> </ol> Click the Eye icon to show or hide the password of your wireless network. When the Eye icon is slashed  , you'll see the password in plain text. Otherwise, it is hidden. |
|                                 | Click this  to show more fields in this section. Click again to hide them.  |
| Encryption                      | This field shows the <b>AES</b> type of data encryption.   |
| Timer                           | The <b>Timer</b> is the rate at which the RADIUS server sends a new group key out to all clients.  |

## 7.3 Guest/More AP

This screen allows you to configure a guest wireless network that allows access to the Internet only through the WX Device. You can also configure additional wireless networks, each with different security settings, in this screen.

Click **Network Setting > Wireless > Guest/More AP**. The following screen displays.

The following table introduces the supported wireless networks.

Table 21 Supported Wireless Networks

| WIRELESS NETWORKS | WHERE TO CONFIGURE                                |
|-------------------|---|
| Main/1            | Network Setting > Wireless > General screen       |
| Guest/3           | Network Setting > Wireless > Guest/More AP screen |

Figure 46 Network Setting > Wireless > Guest/More AP



The following table describes the labels in this screen.

Table 22 Network Setting > Wireless > Guest/More AP

| LABEL      | DESCRIPTION  |
|------------|--|
| #          | This is the index number of the entry.   |
| Status     | This field indicates whether this SSID is active. A yellow bulb signifies that this SSID is active, while a gray bulb signifies that this SSID is not active.  |
| SSID       | An SSID profile is the set of parameters relating to one of the WX Device's BSSs. The SSID (Service Set Identifier) identifies the Service Set with which a wireless device is associated.<br><br>This field displays the name of the wireless profile on the network. When a wireless client scans for an AP to associate with, this is the name that is broadcast and seen in the wireless client utility. |
| Security   | This field indicates the security mode of the SSID profile.  |
| Guest WLAN | This displays if the guest WiFi function has been enabled for this wireless LAN.<br><br>If <b>Home Guest</b> displays, clients can connect to each other directly.<br><br>If <b>External Guest</b> displays, clients are blocked from connecting to each other directly.<br><br><b>N/A</b> displays if guest wireless LAN is disabled.   |
| Modify     | Click the <b>Edit</b> icon to configure the SSID profile.  |

### 7.3.1 Edit Guest/More AP Settings

Use this screen to create Guest and additional wireless networks with different security settings.

Click the **Edit** icon next to an SSID in the **Guest/More AP** screen. The following screen displays.

Figure 47 Network Setting &gt; Wireless &gt; Guest/More AP &gt; Edit

The following table describes the fields in this screen.

Table 23 Network Setting &gt; Wireless &gt; Guest/More AP &gt; Edit



| LABEL                     | DESCRIPTION  |
|---------------------------|--|
| Wireless Network Setup    |  |
| Wireless                  | Click this switch to enable or disable WiFi in this field. When the switch turns blue  , the function is enabled; otherwise, it is not.   |
| Wireless Network Settings |  |
| Wireless Network Name     | The SSID (Service Set Identity) identifies the service set with which a wireless device is associated. Wireless devices associating to the access point (AP) must have the same SSID.<br>Enter a descriptive name (up to 32 English keyboard characters) for WiFi. |
| Hide SSID                 | Select this check box to hide the SSID in the outgoing beacon frame so a station cannot obtain the SSID through scanning using a site survey tool.   |
| Guest WLAN                | Select this to create Guest WiFi for home and external clients. Select the WiFi type in the <b>Access Scenario</b> field.  |

Table 23 Network Setting &gt; Wireless &gt; Guest/More AP &gt; Edit (continued)

| LABEL                           | DESCRIPTION   |
|---------------------------------|---|
| Access Scenario                 | If you select <b>Home Guest</b> , clients can connect to each other directly.<br>If you select <b>External Guest</b> , clients are blocked from connecting to each other directly.  |
| BSSID                           | This shows the MAC address of the wireless interface on the WX Device when WiFi is enabled.   |
| Security Level                  | Select <b>More Secure (Recommended)</b> to add security on this wireless network. The wireless clients which want to associate to this network must have the same wireless security settings as the WX Device. After you select to use a security, additional options appears in this screen.<br><br>Or you can select <b>No Security</b> to allow any client to associate this network without any data encryption or authentication.<br><br>See <a href="#">Section 7.2.1 on page 96</a> for more details about this field.   |
| Security Mode                   | Select the security mode the WX Device uses.<br>Select <b>WPA2-PSK</b> , <b>WPA3-SAE</b> or <b>WPA3-SAE/WPA2-PSK</b> to add security on this wireless network. The wireless clients which want to associate to this network must have same wireless security settings as this device. Or you can select <b>No Security</b> to allow any client to associate this network without authentication..   |
| Generate password automatically | Select this option to have the WX Device automatically generate a password. The password field will not be configurable when you select this option.  |
| Password                        | WPA2-PSK uses a simple common password, instead of user-specific credentials.<br><br>If you did not select <b>Generate password automatically</b> , you can manually type a pre-shared key from 8 to 64 case-sensitive keyboard characters.<br><br>Click the Eye icon to show or hide the password of your wireless network. When the Eye icon is slashed  , you'll see the password in plain text. Otherwise, it is hidden.<br><br>Click this  to show more fields in this section. Click again to hide them. |
| Encryption                      | This field shows the <b>AES</b> type of data encryption.  |
| Timer                           | The <b>Timer</b> is the rate at which the RADIUS server sends a new group key out to all clients.   |
| Cancel                          | Click <b>Cancel</b> to exit this screen without saving any changes.   |
| OK                              | Click <b>OK</b> to save your changes.   |

## 7.4 MAC Authentication

This screen allows you to configure the WX Device to give exclusive access to specific devices (**Allow**) or exclude specific devices from accessing the WX Device (**Deny**) based on the device(s) MAC address. Every Ethernet device has a unique MAC (Media Access Control) address. It is assigned at the factory and consists of six pairs of hexadecimal characters; for example, 00:A0:C5:00:00:02. You need to know the MAC addresses of the device(s) you want to allow/deny to configure this screen.

Note: You can have up to 25 MAC authentication rules.

Use this screen to view your WX Device's MAC filter settings and add new MAC filter rules. Click **Network**

**Setting > Wireless > MAC Authentication.** The screen appears as shown.

**Figure 48** Network Setting> Wireless > MAC Authentication

**Wireless**

General | Guest/More AP | **MAC Authentication** | WPS | WMM | Other | Channel Status

This screen allows you to configure the Zyxel Device to give exclusive access to specific devices (**Allow**) or exclude specific devices from accessing the Zyxel Device (**Deny**) based on the device(s) MAC address. Every Ethernet device has a unique MAC (Media Access Control) address. It is assigned at the factory and consists of six pairs of hexadecimal characters, for example, 00:A0:C3:00:00:02. You need to know the MAC addresses of the device(s) you want to allow/deny to configure this screen.

**General**

SSID: Zyxel\_0016

MAC Restrict Mode:  Disable  Deny  Allow

**MAC address List**

+ Add new MAC address

| # | MAC Address | Modify |
|---|-------------|--------|
|   |             |        |

Note  
You can have up to 25 MAC authentication rules.

Cancel Apply

The following table describes the labels in this screen.

**Table 24** Network Setting > Wireless > MAC Authentication

| LABEL               | DESCRIPTION  |
|---------------------|--|
| General             |  |
| SSID                | Select the SSID for which you want to configure MAC filter settings.   |
| MAC Restrict Mode   | Define the filter action for the list of MAC addresses in the <b>MAC Address</b> table.<br>Select <b>Disable</b> to turn off MAC filtering.<br>Select <b>Deny</b> to block access to the WX Device. MAC addresses not listed will be allowed to access the WX Device.<br>Select <b>Allow</b> to permit access to the WX Device. MAC addresses not listed will be denied access to the WX Device. |
| MAC Address List    |  |
| Add New MAC Address | This field is available when you select <b>Deny</b> or <b>Allow</b> in the <b>MAC Restrict Mode</b> field.<br>Click this if you want to add a new MAC address entry to the MAC filter list below.  |
| #                   | This is the index number of the entry.   |
| MAC Address         | This is the MAC addresses of the wireless devices that are allowed or denied access to the WX Device.  |
| Modify              | Click the <b>Edit</b> icon and type the MAC address of the peer device in a valid MAC address format (six hexadecimal character pairs, for example 12:34:56:78:9a:bc).<br>Click the <b>Delete</b> icon to delete the entry.  |
| Cancel              | Click <b>Cancel</b> to restore the default or previously saved settings.   |
| Apply               | Click <b>Apply</b> to save your changes.   |

## 7.4.1 Add/Edit MAC Addresses

Click **Add new MAC address** in the **Network Setting > Wireless > MAC Authentication** screen to add a new MAC address. You can also click the Edit icon next to a MAC authentication rule to edit the rule.

Enter the MAC addresses of the wireless devices that are allowed or denied access to the WX Device in these address fields. Enter the MAC addresses in a valid MAC address format, that is, six hexadecimal character pairs, for example, 12:34:56:78:9a:bc.

**Figure 49** Network Setting> Wireless > MAC Authentication > Add/Edit

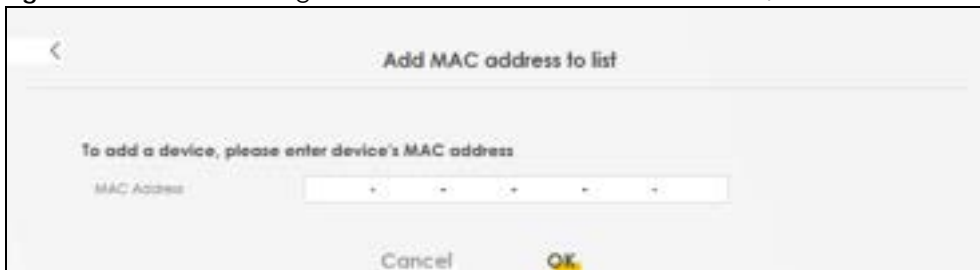

## 7.5 WPS Settings

WiFi Protected Setup (WPS) allows you to quickly set up a wireless network with strong security, without having to configure security settings manually. To set up a WPS connection between two devices, both devices must support WPS. It is recommended to use the Push Button Configuration (**PBC**) method if your wireless client supports it. See [Section 7.11.8.3 on page 119](#) for more information about WPS.

Note: The WX Device applies the security settings of the main SSID (**SSID1**) profile (see [Section 7.2 on page 93](#)).

Note: The WPS switch is grayed out when WiFi is disabled.

Click **Network Setting > Wireless > WPS**. The following screen displays. Click this switch and makes it turn blue. Click **Apply** to activate the WPS function. Then you can configure the WPS settings in this screen.

Figure 50 Network Setting &gt; Wireless &gt; WPS

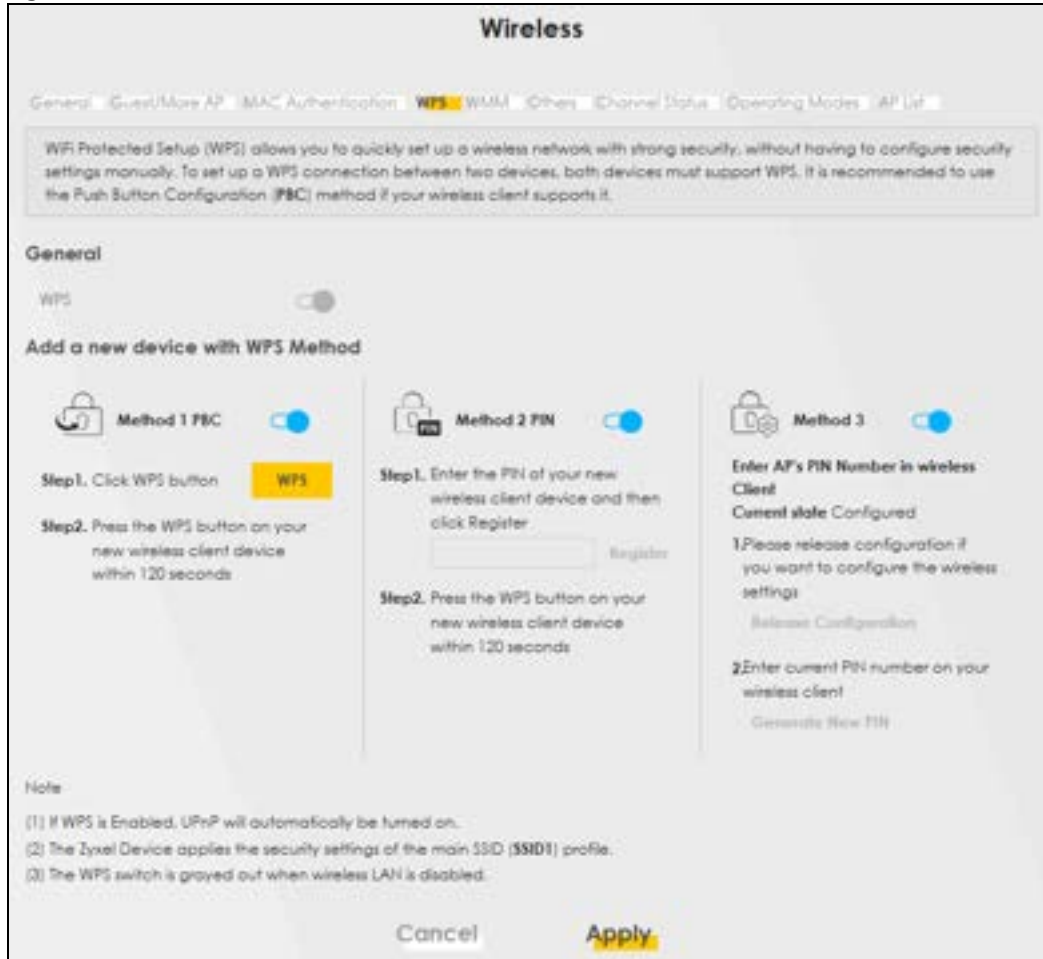

The following table describes the labels in this screen.

Table 25 Network Setting &gt; Wireless &gt; WPS

| LABEL                            | DESCRIPTION  |
|----------------------------------|--|
| General                          |  |
| WPS                              | Click this switch to activate or deactivate WPS on this WX Device. When the switch turns blue  , the function is enabled. Otherwise, it is not.   |
| Add a new device with WPS Method |  |
| Method 1                         | Use this section to set up a WPS wireless network using Push Button Configuration (PBC). Click this switch to make it turn blue. Click <b>Apply</b> to activate WPS method 1 on the WX Device.   |
| WPS                              | Click this button to add another WPS-enabled wireless device (within wireless range of the WX Device) to your wireless network. This button may either be a physical button on the outside of device, or a menu button similar to the <b>WPS</b> button on this screen.<br><br>Note: You must press the other wireless device's WPS button within two minutes of pressing this button. |
| Method 2                         | Use this section to set up a WPS wireless network by entering the PIN of the client into the WX Device. Click this switch and make it turn blue. Click <b>Apply</b> to activate WPS method 2 on the WX Device.   |

Table 25 Network Setting &gt; Wireless &gt; WPS (continued)

| LABEL                 | DESCRIPTION  |
|-----------------------|--|
| Register              | <p>Enter the PIN of the device that you are setting up a WPS connection with and click <b>Register</b> to authenticate and add the wireless device to your wireless network.</p> <p>You can find the PIN either on the outside of the device, or by checking the device's settings.</p> <p>Note: You must also activate WPS on that device within two minutes to have it present its PIN to the WX Device.</p> |
| Method 3              | <p>Use this section to set up a WPS wireless network by entering the PIN of the WX Device into the client. Click this switch and make it turn blue. Click <b>Apply</b> to activate WPS method 3 on the WX Device.</p>  |
| Release Configuration | <p>The default WPS status is configured.</p> <p>Click this button to remove all configured wireless and wireless security settings for WPS connections on the WX Device.</p>   |
| Generate New PIN      | <p>If this method has been enabled, the PIN (Personal Identification Number) of the WX Device is shown here. Enter this PIN in the configuration utility of the device you want to connect to using WPS.</p> <p>The PIN is not necessary when you use the WPS push-button method.</p> <p>Click the <b>Generate New PIN</b> button to have the WX Device create a new PIN.</p>                                  |
| Cancel                | <p>Click <b>Cancel</b> to restore the default or previously saved settings.</p>  |
| Apply                 | <p>Click <b>Apply</b> to save your changes.</p>  |

## 7.6 WMM Settings

Use this screen to enable WiFi MultiMedia (**WMM**) and **WMM Automatic Power Save (APSD)** in wireless networks for multimedia applications. **WMM** enhances data transmission quality, while **APSD** improves power management of wireless clients. This allows delay-sensitive applications, such as voice and videos, to run more smoothly.

Click **Network Setting > Wireless > WMM** to display the following screen.



Figure 51 Network Setting &gt; Wireless &gt; WMM



Note: **WMM** cannot be disabled if 802.11 mode includes 802.11n or 802.11ac.

The following table describes the labels in this screen.

Table 26 Network Setting &gt; Wireless &gt; WMM

| LABEL                                    | DESCRIPTION   |
|--|---|
| WMM of SSID1~4                           | Select <b>On</b> to have the WX Device automatically give the wireless network (SSIDx) a priority level according to the ToS value in the IP header of packets it sends. WMM QoS (WiFi MultiMedia Quality of Service) gives high priority to voice and video, which makes them run more smoothly.<br><br>If the <b>802.11 Mode</b> in <b>Network Setting &gt; Wireless &gt; Others</b> is set to include 802.11n or 802.11ac, WMM cannot be disabled.   |
| WMM Automatic Power Save Delivery (APSD) | Select this option to extend the battery life of your mobile devices (especially useful for small devices that are running multimedia applications). The WX Device goes to sleep mode to save power when it is not transmitting data. The AP buffers the packets sent to the WX Device until the WX Device "wakes up". The WX Device wakes up periodically to check for incoming data.<br><br>Note: This works only if the wireless device to which the WX Device is connected also supports this feature.<br>APSD only affects SSID1. For SSID2~4, APSD is always enabled. |
| Cancel                                   | Click <b>Cancel</b> to restore the default or previously saved settings.  |
| Apply                                    | Click <b>Apply</b> to save your changes.  |

## 7.7 Others Settings

Use this screen to configure advanced wireless settings, such as additional security settings, power saving, and data transmission settings. Click **Network Setting > Wireless > Others**. The screen appears as shown.

See [Section 7.11.2 on page 113](#) for detailed definitions of the terms listed in this screen.

Figure 52 Network Setting &gt; Wireless &gt; Others

Use this screen to configure advanced wireless settings, additional security settings, power saving, and data transmission settings.

Output Power: 100%

Beacon Interval: 100 ms

DTIM Interval: 1 ms

802.11 Mode: 802.11b/g/n/ax Mixed

Protected Management Frames: Capable

Cancel Apply

The following table describes the labels in this screen.

Table 27 Network Setting &gt; Wireless &gt; Others

| LABEL           | DESCRIPTION   |
|-----------------|---|
| Output Power    | Set the output power of the WX Device. If there is a high density of APs in an area, decrease the output power to reduce interference with other APs. Select one of the following: <b>20%</b> , <b>40%</b> , <b>60%</b> , <b>80%</b> or <b>100%</b> .   |
| Beacon Interval | When a wirelessly networked device sends a beacon, it includes with it a beacon interval. This specifies the time period before the device sends the beacon again.<br><br>The interval tells receiving devices on the network how long they can wait in low power mode before waking up to handle the beacon. This value can be set from 50 ms to 1000 ms. A high value helps save current consumption of the access point. |
| DTIM Interval   | Delivery Traffic Indication Message (DTIM) is the time period after which broadcast and multicast packets are transmitted to mobile clients in the Power Saving mode. A high DTIM value can cause clients to lose connectivity with the network. This value can be set from 1 to 255.   |

Table 27 Network Setting &gt; Wireless &gt; Others (continued)

| LABEL                       | DESCRIPTION   |
|-----------------------------|---|
| 802.11 Mode                 | <p>For 2.4 GHz frequency WiFi devices:</p> <ul style="list-style-type: none"> <li>• Select <b>802.11b Only</b> to allow only IEEE 802.11b compliant WiFi devices to associate with the WX Device.</li> <li>• Select <b>802.11g Only</b> to allow only IEEE 802.11g compliant WiFi devices to associate with the WX Device.</li> <li>• Select <b>802.11n Only</b> to allow only IEEE 802.11n compliant WiFi devices to associate with the WX Device.</li> <li>• Select <b>802.11b/g Mixed</b> to allow either IEEE 802.11b or IEEE 802.11g compliant WiFi devices to associate with the WX Device. The transmission rate of your WX Device might be reduced.</li> <li>• Select <b>802.11b/g/n Mixed</b> to allow IEEE 802.11b, IEEE 802.11g or IEEE 802.11n compliant WiFi devices to associate with the WX Device. The transmission rate of your WX Device might be reduced.</li> <li>• Select <b>802.11b/g/n/ax Mixed</b> to allow IEEE 802.11b, IEEE 802.11g, IEEE 802.11n or IEEE 802.11ax compliant WiFi devices to associate with the WX Device. The transmission rate of your WX Device might be reduced.</li> </ul> <p>For 5 GHz frequency WiFi devices:</p> <ul style="list-style-type: none"> <li>• Select <b>802.11a Only</b> to allow only IEEE 802.11a compliant WiFi devices to associate with the WX Device.</li> <li>• Select <b>802.11n Only</b> to allow only IEEE 802.11n compliant WiFi devices to associate with the WX Device.</li> <li>• Select <b>802.11ac Only</b> to allow only IEEE 802.11ac compliant WiFi devices to associate with the WX Device.</li> <li>• Select <b>802.11a/n Mixed</b> to allow either IEEE 802.11a or IEEE 802.11n compliant WiFi devices to associate with the WX Device. The transmission rate of your WX Device might be reduced.</li> <li>• Select <b>802.11n/ac Mixed</b> to allow either IEEE 802.11n or IEEE 802.11ac compliant WiFi devices to associate with the WX Device. The transmission rate of your WX Device might be reduced.</li> <li>• Select <b>802.11a/n/ac Mixed</b> to allow IEEE 802.11a, IEEE 802.11n or IEEE 802.11ac compliant WiFi devices to associate with the WX Device. The transmission rate of your WX Device might be reduced.</li> <li>• Select <b>802.11a/n/ac/ax Mixed</b> to allow IEEE 802.11a, IEEE 802.11n, IEEE 802.11ac or IEEE 802.11ax compliant WiFi devices to associate with the WX Device. The transmission rate of your WX Device might be reduced.</li> </ul> |
| Protected Management Frames | <p>This option is only available when using <b>WPA2-PSK</b> as the <b>Security Mode</b> and <b>AES</b> Encryption in <b>Network Setting &gt; Wireless &gt; General</b>. Management frame protection (MFP) helps prevent wireless DoS attacks.</p> <p>Select <b>Disable</b> if you do not want to use MFP.</p> <p>Select <b>Capable</b> to encrypt management frames of wireless clients that support MFP. Clients that do not support MFP will still be allowed to join the wireless network, but remain unprotected.</p> <p>Select <b>Required</b> to allow only clients that support MFP to join the wireless network.</p>  |
| Cancel                      | Click <b>Cancel</b> to restore the default or previously saved settings.  |
| Apply                       | Click <b>Apply</b> to save your changes.  |

## 7.8 Channel Status Settings

Use the **Channel Status** screen to scan WiFi channel noises and view the results. Click **Network Setting > Wireless > Channel Status**. The screen appears as shown. Click **Scan** to scan the WiFi channels. You can view the results in the **Channel Scan Result** section.

Note: If the current channel is a DFS channel, the warning 'Channel scan process is denied because current channel is a DFS channel (Channel: 52~140). If you want to run channel scan, please select a non-DFS channel and try again.' appears.

Figure 53 Network Setting > Wireless > Channel Status



## 7.9 Operating Modes Settings

Use this screen to manually enter the SSID and security settings of the AP to which you want the WX Device to connect. This screen allows you to set a profile so that the WX Device will automatically try to connect to the AP specified in the profile each time the WX Device in Repeater mode is turned on.

Click **Network Setting > Wireless > Operating Modes**. The screen appears as shown.

Note: The **Operating Mode** is available when you select 5GHz wireless connection. (See [Section 7.2 on page 93](#)).

Figure 54 Network Setting &gt; Wireless &gt; Operating Modes

The following table describes the labels in this screen.

Table 28 Network Setting &gt; Wireless &gt; Operating Modes

| LABEL                 | DESCRIPTION  |
|-----------------------|--|
| Operating Modes       |  |
| Modes                 | This displays the operating mode of the WX Device. <ul style="list-style-type: none"> <li>If the WX Device is connected to the AP using a cable, the WX Device will be in the AP mode.</li> <li>If the WX Device is connected to the AP wirelessly, the WX Device will be in the repeater mode.</li> </ul> |
| Wireless Setup        |  |
| Wireless Network Name | Enter the name of the wireless network (SSID) to which the WX Device is connecting.  |
| Security Mode         | Select the security mode the AP uses from the drop down list box.  |
| Password              | Enter the password of the wireless network to which the WX Device is connecting.   |
| WPS Setup             |  |

Table 28 Network Setting &gt; Wireless &gt; Operating Modes

| LABEL            | DESCRIPTION   |
|------------------|---|
| WPS              | Select this to activate or deactivate the WPS method.               |
| Click WPS button | Click this to connect the WX Device to the AP using the WPS method. |
| Apply            | Click <b>Apply</b> to save your changes.                            |
| Cancel           | Click <b>Cancel</b> to begin configuring this screen afresh.        |

## 7.10 AP List Screen

You can use this screen to select an AP and enter its WiFi password to connect to the wireless network.

Click **Network Setting > Wireless > AP List**. The screen appears as shown.

Note: The **AP List** is available when you select 5GHz wireless connection. (See [Section 7.2 on page 93](#)).

Figure 55 Network Setting &gt; Wireless &gt; AP List

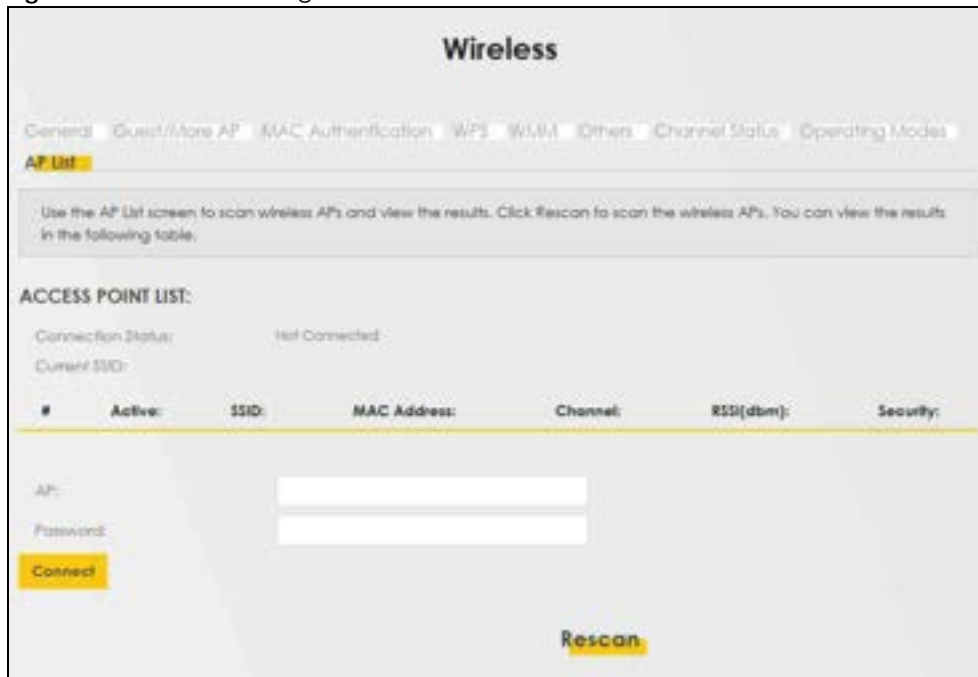

The following table describes the labels in this screen.

Table 29 Network Setting &gt; Wireless &gt; AP List

| LABEL             | DESCRIPTION   |
|-------------------|---|
| Connection Status | This shows whether the WX Device is already connected, attempting to connect, or not connected to a wireless network. |
| Current SSID      | This shows the name of the AP to which your WX Device is currently connected.   |
| #                 | This is the index number of the AP the WX Device can detect.  |
| Active            | This field indicates whether the AP is active or not.   |

Table 29 Network Setting &gt; Wireless &gt; AP List

| LABEL       | DESCRIPTION  |
|-------------|--|
| SSID        | This shows the network name of the AP the WX Device can detect.  |
| MAC Address | This shows the MAC address of the AP.  |
| Channel     | This shows the channel the AP uses.  |
| RSSI (dbm)  | This shows the strength of the AP's radio signal measured in dbm.  |
| Security    | This shows <b>Yes</b> if the WX Device needs a security password to connect to the AP. It shows <b>No</b> if the WX Device does not need a password to connect.                            |
| AP          | This shows the name of the AP you click and try to connect.  |
| Password    | The <b>Password</b> input box displays when the <b>Security</b> column is <b>Yes</b> for the selected SSID. Enter the password for this wireless network in the <b>Password</b> input box. |
| Connect     | The <b>Connect</b> button appears at the end of the table after you click on a SSID.<br>Click this button to connect to the selected AP.   |
| Rescan      | Click <b>Rescan</b> to refresh the list of APs available.  |

## 7.11 Technical Reference

This section discusses WiFi in depth. For more information, see [Appendix B on page 165](#).

### 7.11.1 Wireless Network Overview

Wireless networks consist of wireless clients, access points and bridges.

- A wireless client is a radio connected to a user's computer.
- An access point is a radio with a wired connection to a network, which can connect with numerous wireless clients and let them access the network.
- A bridge is a radio that relays communications between access points and wireless clients, extending a network's range.

Traditionally, a wireless network operates in one of two ways.

- An "infrastructure" type of network has one or more access points and one or more wireless clients. The wireless clients connect to the access points.
- An "ad-hoc" type of network is one in which there is no access point. Wireless clients connect to one another in order to exchange information.

The following figure provides an example of a wireless network.

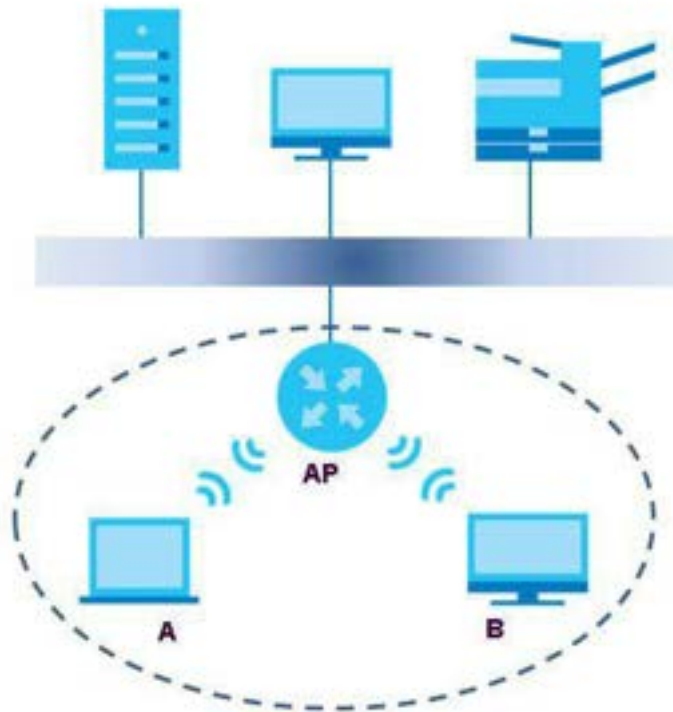
**Figure 56** Example of a Wireless Network

The wireless network is the part in the blue circle. In this wireless network, devices **A** and **B** use the access point (**AP**) to interact with the other devices (such as the printer) or with the Internet. Your WX Device is the AP.

Every wireless network must follow these basic guidelines.

- Every device in the same wireless network must use the same SSID.  
The SSID is the name of the wireless network. It stands for Service Set Identifier.
- If two wireless networks overlap, they should use a different channel.  
Like radio stations or television channels, each wireless network uses a specific channel, or frequency, to send and receive information.
- Every device in the same wireless network must use security compatible with the AP.  
Security stops unauthorized devices from using the wireless network. It can also protect the information that is sent in the wireless network.

## Radio Channels

In the radio spectrum, there are certain frequency bands allocated for unlicensed, civilian use. For the purposes of wireless networking, these bands are divided into numerous channels. This allows a variety of networks to exist in the same place without interfering with one another. When you create a network, you must select a channel to use.

Since the available unlicensed spectrum varies from one country to another, the number of available channels also varies.



## 7.11.2 Additional Wireless Terms

The following table describes some wireless network terms and acronyms used in the WX Device's Web Configurator.

Table 30 Additional Wireless Terms

| TERM                    | DESCRIPTION  |
|-------------------------|--|
| RTS/CTS Threshold       | <p>In a wireless network which covers a large area, wireless devices are sometimes not aware of each other's presence. This may cause them to send information to the AP at the same time and result in information colliding and not getting through.</p> <p>By setting this value lower than the default value, the wireless devices must sometimes get permission to send information to the WX Device. The lower the value, the more often the devices must get permission.</p> <p>If this value is greater than the fragmentation threshold value (see below), then wireless devices never have to get permission to send information to the WX Device.</p> |
| Preamble                | A preamble affects the timing in your wireless network. There are two preamble modes: long and short. If a device uses a different preamble mode than the WX Device does, it cannot communicate with the WX Device.  |
| Authentication          | The process of verifying whether a wireless device is allowed to use the wireless network.   |
| Fragmentation Threshold | A small fragmentation threshold is recommended for busy networks, while a larger threshold provides faster performance if the network is not very busy.  |

## 7.11.3 Wireless Security Overview

By their nature, radio communications are simple to intercept. For wireless data networks, this means that anyone within range of a wireless network without security can not only read the data passing over the airwaves, but also join the network. Once an unauthorized person has access to the network, he or she can steal information or introduce malware (malicious software) intended to compromise the network. For these reasons, a variety of security systems have been developed to ensure that only authorized people can use a wireless data network, or understand the data carried on it.

These security standards do two things. First, they authenticate. This means that only people presenting the right credentials (often a username and password, or a "key" phrase) can access the network. Second, they encrypt. This means that the information sent over the air is encoded. Only people with the code key can understand the information, and only people who have been authenticated are given the code key.

These security standards vary in effectiveness. Some can be broken, such as the old Wired Equivalent Protocol (WEP). Using WEP is better than using no security at all, but it will not keep a determined attacker out. Other security standards are secure in themselves but can be broken if a user does not use them properly. For example, the WPA-PSK security standard is very secure if you use a long key which is difficult for an attacker's software to guess - for example, a twenty-letter long string of apparently random numbers and letters - but it is not very secure if you use a short key which is very easy to guess - for example, a three-letter word from the dictionary.

Because of the damage that can be done by a malicious attacker, it's not just people who have sensitive information on their network who should use security. Everybody who uses any wireless network should ensure that effective security is in place.

A good way to come up with effective security keys, passwords and so on is to use obscure information that you personally will easily remember, and to enter it in a way that appears random and does not include real words. For example, if your mother owns a 1970 Dodge Challenger and her favorite movie is

Vanishing Point (which you know was made in 1971) you could use "70dodchal71vanpoi" as your security key.

The following sections introduce different types of wireless security you can set up in the wireless network.

### 7.11.3.1 SSID

Normally, the WX Device acts like a beacon and regularly broadcasts the SSID in the area. You can hide the SSID instead, in which case the WX Device does not broadcast the SSID. In addition, you should change the default SSID to something that is difficult to guess.

This type of security is fairly weak, however, because there are ways for unauthorized wireless devices to get the SSID. In addition, unauthorized wireless devices can still see the information that is sent in the wireless network.

### 7.11.3.2 MAC Address Filter

Every device that can use a wireless network has a unique identification number, called a MAC address.<sup>1</sup> A MAC address is usually written using twelve hexadecimal characters<sup>2</sup>; for example, 00A0C5000002 or 00:A0:C5:00:00:02. To get the MAC address for each device in the wireless network, see the device's User's Guide or other documentation.

You can use the MAC address filter to tell the WX Device which devices are allowed or not allowed to use the wireless network. If a device is allowed to use the wireless network, it still has to have the correct information (SSID, channel, and security). If a device is not allowed to use the wireless network, it does not matter if it has the correct information.

This type of security does not protect the information that is sent in the wireless network. Furthermore, there are ways for unauthorized wireless devices to get the MAC address of an authorized device. Then, they can use that MAC address to use the wireless network.

### 7.11.3.3 User Authentication

Authentication is the process of verifying whether a wireless device is allowed to use the wireless network. You can make every user log in to the wireless network before using it. However, every device in the wireless network has to support IEEE 802.1x to do this.

For wireless networks, you can store the user names and passwords for each user in a RADIUS server. This is a server used in businesses more than in homes. If you do not have a RADIUS server, you cannot set up user names and passwords for your users.

Unauthorized wireless devices can still see the information that is sent in the wireless network, even if they cannot use the wireless network. Furthermore, there are ways for unauthorized wireless users to get a valid user name and password. Then, they can use that user name and password to use the wireless network.

- 
1. Some wireless devices, such as scanners, can detect wireless networks but cannot use wireless networks. These kinds of wireless devices might not have MAC addresses.
  2. Hexadecimal characters are 0, 1, 2, 3, 4, 5, 6, 7, 8, 9, A, B, C, D, E, and F.

### 7.11.3.4 Encryption

Wireless networks can use encryption to protect the information that is sent in the wireless network. Encryption is like a secret code. If you do not know the secret code, you cannot understand the message.

Many types of encryption use a key to protect the information in the wireless network. The longer the key, the stronger the encryption. Every device in the wireless network must have the same key.

### 7.11.4 Signal Problems

Because wireless networks are radio networks, their signals are subject to limitations of distance, interference and absorption.

Problems with distance occur when the two radios are too far apart. Problems with interference occur when other radio waves interrupt the data signal. Interference may come from other radio transmissions, such as military or air traffic control communications, or from machines that are coincidental emitters such as electric motors or microwaves. Problems with absorption occur when physical objects (such as thick walls) are between the two radios, muffling the signal.

### 7.11.5 BSS

A Basic Service Set (BSS) exists when all communications between wireless stations or between a wireless station and a wired network client go through one access point (AP).

Intra-BSS traffic is traffic between wireless stations in the BSS. When Intra-BSS traffic blocking is disabled, wireless station A and B can access the wired network and communicate with each other. When Intra-BSS traffic blocking is enabled, wireless station A and B can still access the wired network but cannot communicate with each other.

Figure 57 Basic Service Set

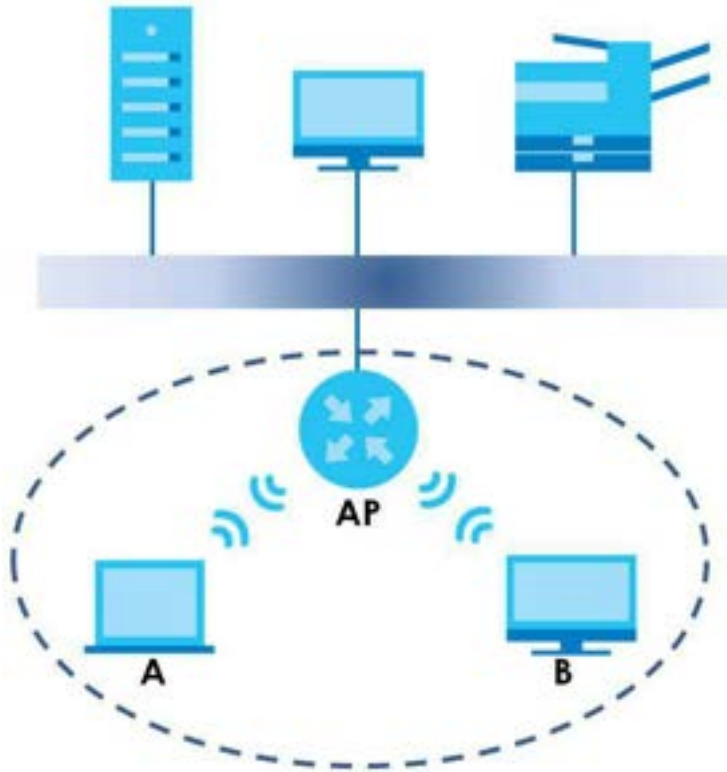

## 7.11.6 MBSSID

Traditionally, you need to use different APs to configure different Basic Service Sets (BSSs). As well as the cost of buying extra APs, there is also the possibility of channel interference. The WX Device's MBSSID (Multiple Basic Service Set Identifier) function allows you to use one access point to provide several BSSs simultaneously. You can then assign varying QoS priorities and/or security modes to different SSIDs.

Wireless devices can use different BSSIDs to associate with the same AP.

### 7.11.6.1 Notes on Multiple BSSs

- A maximum of eight BSSs are allowed on one AP simultaneously.
- You must use different keys for different BSSs. If two wireless devices have different BSSIDs (they are in different BSSs), but have the same keys, they may hear each other's communications (but not communicate with each other).
- MBSSID should not replace but rather be used in conjunction with 802.1x security.

## 7.11.7 Preamble Type

Preamble is used to signal that data is coming to the receiver. Short and long refer to the length of the synchronization field in a packet.

Short preamble increases performance as less time sending preamble means more time for sending data. All IEEE 802.11 compliant wireless adapters support long preamble, but not all support short preamble.

Use long preamble if you are unsure what preamble mode other wireless devices on the network support, and to provide more reliable communications in busy wireless networks.

Use short preamble if you are sure all wireless devices on the network support it, and to provide more efficient communications.

Use the dynamic setting to automatically use short preamble when all wireless devices on the network support it, otherwise the WX Device uses long preamble.

Note: The wireless devices MUST use the same preamble mode in order to communicate.

## 7.11.8 WiFi Protected Setup (WPS)

Your WX Device supports WiFi Protected Setup (WPS), which is an easy way to set up a secure wireless network. WPS is an industry standard specification, defined by the WiFi Alliance.

WPS allows you to quickly set up a wireless network with strong security, without having to configure security settings manually. Each WPS connection works between two devices. Both devices must support WPS (check each device's documentation to make sure).

Depending on the devices you have, you can either press a button (on the device itself, or in its configuration utility) or enter a PIN (a unique Personal Identification Number that allows one device to authenticate the other) in each of the two devices. When WPS is activated on a device, it has two minutes to find another device that also has WPS activated. Then, the two devices connect and set up a secure network by themselves.

### 7.11.8.1 Push Button Configuration

WPS Push Button Configuration (PBC) is initiated by pressing a button on each WPS-enabled device, and allowing them to connect automatically. You do not need to enter any information.

Not every WPS-enabled device has a physical WPS button. Some may have a WPS PBC button in their configuration utilities instead of or in addition to the physical button.

Take the following steps to set up WPS using the button.

- 1 Ensure that the two devices you want to set up are within wireless range of one another.
- 2 Look for a WPS button on each device. If the device does not have one, log into its configuration utility and locate the button (see the device's User's Guide for how to do this - for the WX Device, see [Section 7.6 on page 104](#)).
- 3 Press the button on one of the devices (it does not matter which). For the WX Device you must press the WPS button for more than five seconds.
- 4 Within two minutes, press the button on the other device. The registrar sends the network name (SSID) and security key through a secure connection to the enrollee.

If you need to make sure that WPS worked, check the list of associated wireless clients in the AP's configuration utility. If you see the wireless client in the list, WPS was successful.

### 7.11.8.2 PIN Configuration

Each WPS-enabled device has its own PIN (Personal Identification Number). This may either be static (it cannot be changed) or dynamic (in some devices you can generate a new PIN by clicking on a button in the configuration interface).

Use the PIN method instead of the push-button configuration (PBC) method if you want to ensure that the connection is established between the devices you specify, not just the first two devices to activate WPS in range of each other. However, you need to log into the configuration interfaces of both devices to use the PIN method.

When you use the PIN method, you must enter the PIN from one device (usually the wireless client) into the second device (usually the Access Point or wireless router). Then, when WPS is activated on the first device, it presents its PIN to the second device. If the PIN matches, one device sends the network and security information to the other, allowing it to join the network.

Take the following steps to set up a WPS connection between an access point or wireless router (referred to here as the AP) and a client device using the PIN method.

- 1 Ensure WPS is enabled on both devices.
- 2 Access the WPS section of the AP's configuration interface. See the device's User's Guide for how to do this.
- 3 Look for the client's WPS PIN; it will be displayed either on the device, or in the WPS section of the client's configuration interface (see the device's User's Guide for how to find the WPS PIN - for the WX Device, see [Section 7.5 on page 102](#)).
- 4 Enter the client's PIN in the AP's configuration interface.
- 5 If the client device's configuration interface has an area for entering another device's PIN, you can either enter the client's PIN in the AP, or enter the AP's PIN in the client - it does not matter which.
- 6 Start WPS on both devices within two minutes.
- 7 Use the configuration utility to activate WPS, not the push-button on the device itself.
- 8 On a computer connected to the wireless client, try to connect to the Internet. If you can connect, WPS was successful.

If you cannot connect, check the list of associated wireless clients in the AP's configuration utility. If you see the wireless client in the list, WPS was successful.

The following figure shows a WPS-enabled wireless client (installed in a notebook computer) connecting to the WPS-enabled AP via the PIN method.

Figure 58 Example WPS Process: PIN Method

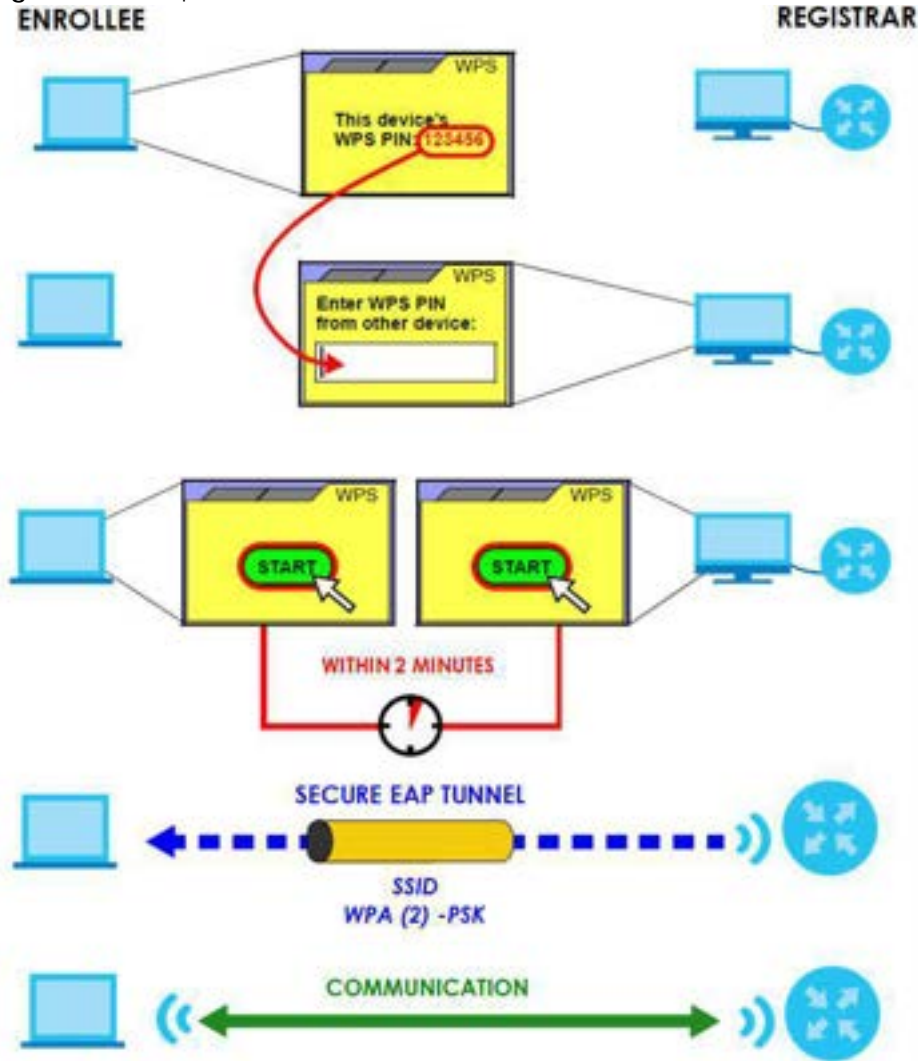

### 7.11.8.3 How WPS Works

When two WPS-enabled devices connect, each device must assume a specific role. One device acts as the registrar (the device that supplies network and security settings) and the other device acts as the enrollee (the device that receives network and security settings). The registrar creates a secure EAP (Extensible Authentication Protocol) tunnel and sends the network name (SSID) and the WPA-PSK or WPA2-PSK pre-shared key to the enrollee. Whether WPA-PSK or WPA2-PSK is used depends on the standards supported by the devices. If the registrar is already part of a network, it sends the existing information. If not, it generates the SSID and WPA2-PSK randomly.

The following figure shows a WPS-enabled client (installed in a notebook computer) connecting to a WPS-enabled access point.

Figure 59 How WPS Works



The roles of registrar and enrollee last only as long as the WPS setup process is active (two minutes). The next time you use WPS, a different device can be the registrar if necessary.

The WPS connection process is like a handshake; only two devices participate in each WPS transaction. If you want to add more devices you should repeat the process with one of the existing networked devices and the new device.

Note that the access point (AP) is not always the registrar, and the wireless client is not always the enrollee. All WPS-certified APs can be a registrar, and so can some WPS-enabled wireless clients.

By default, a WPS device is “unconfigured”. This means that it is not part of an existing network and can act as either enrollee or registrar (if it supports both functions). If the registrar is unconfigured, the security settings it transmits to the enrollee are randomly-generated. Once a WPS-enabled device has connected to another device using WPS, it becomes “configured”. A configured wireless client can still act as enrollee or registrar in subsequent WPS connections, but a configured access point can no longer act as enrollee. It will be the registrar in all subsequent WPS connections in which it is involved. If you want a configured AP to act as an enrollee, you must reset it to its factory defaults.

#### 7.11.8.4 Example WPS Network Setup

This section shows how security settings are distributed in an example WPS setup.

The following figure shows an example network. In step 1, both **AP1** and **Client 1** are unconfigured. When WPS is activated on both, they perform the handshake. In this example, **AP1** is the registrar, and **Client 1** is the enrollee. The registrar randomly generates the security information to set up the network, since it is unconfigured and has no existing information.



Figure 60 WPS: Example Network Step 1



In step 2, you add another wireless client to the network. You know that **Client 1** supports registrar mode, but it is better to use **AP1** for the WPS handshake with the new client since you must connect to the access point anyway in order to use the network. In this case, **AP1** must be the registrar, since it is configured (it already has security information for the network). **AP1** supplies the existing security information to **Client 2**.

Figure 61 WPS: Example Network Step 2



In step 3, you add another access point (**AP2**) to your network. **AP2** is out of range of **AP1**, so you cannot use **AP1** for the WPS handshake with the new access point. However, you know that **Client 2** supports the registrar function, so you use it to perform the WPS handshake instead.

Figure 62 WPS: Example Network Step 3

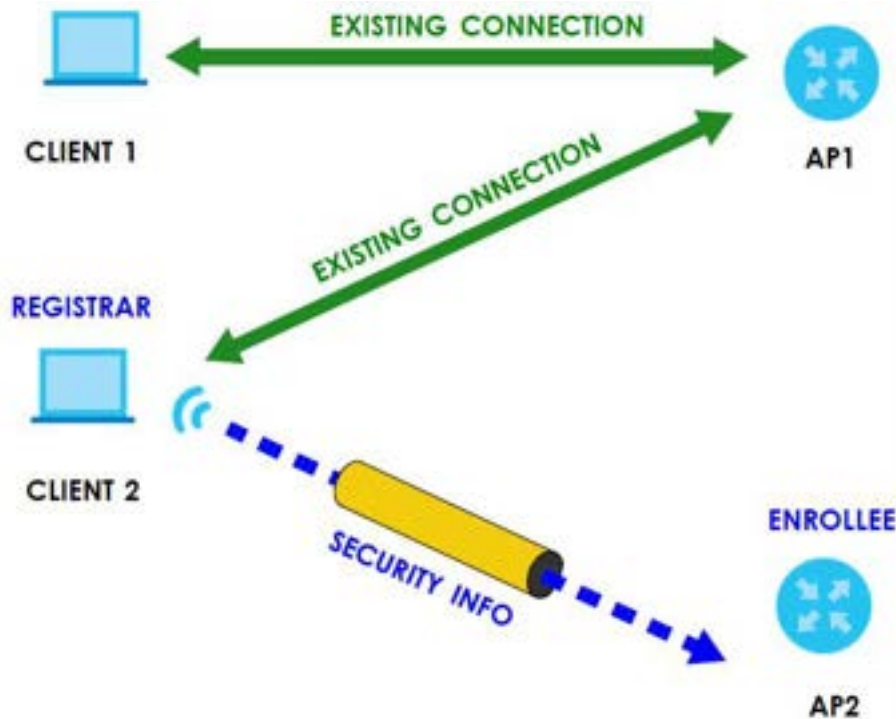

### 7.11.8.5 Limitations of WPS

WPS has some limitations of which you should be aware.

- WPS works in Infrastructure networks only (where an AP and a wireless client communicate). It does not work in Ad-Hoc networks (where there is no AP).
- When you use WPS, it works between two devices only. You cannot enroll multiple devices simultaneously, you must enroll one after the other.

For instance, if you have two enrollees and one registrar you must set up the first enrollee (by pressing the WPS button on the registrar and the first enrollee, for example), then check that it successfully enrolled, then set up the second device in the same way.

- WPS works only with other WPS-enabled devices. However, you can still add non-WPS devices to a network you already set up using WPS.

WPS works by automatically issuing a randomly-generated WPA-PSK or WPA2-PSK pre-shared key from the registrar device to the enrollee devices. Whether the network uses WPA-PSK or WPA2-PSK depends on the device. You can check the configuration interface of the registrar device to discover the key the network is using (if the device supports this feature). Then, you can enter the key into the non-WPS device and join the network as normal (the non-WPS device must also support WPA-PSK or WPA2-PSK).

- When you use the PBC method, there is a short period (from the moment you press the button on one device to the moment you press the button on the other device) when any WPS-enabled device could join the network. This is because the registrar has no way of identifying the "correct" enrollee, and cannot differentiate between your enrollee and a rogue device. This is a possible way for a hacker to gain access to a network.

You can easily check to see if this has happened. WPS works between only two devices simultaneously, so if another device has enrolled your device will be unable to enroll, and will not have access to the network. If this happens, open the access point's configuration interface and look at the list of associated clients (usually displayed by MAC address). It does not matter if the access

point is the WPS registrar, the enrollee, or was not involved in the WPS handshake; a rogue device must still associate with the access point to gain access to the network. Check the MAC addresses of your wireless clients (usually printed on a label on the bottom of the device). If there is an unknown MAC address you can remove it or reset the AP.

# CHAPTER 8

## Home Networking

### 8.1 Home Networking Overview

A Local Area Network (LAN) is a shared communication system to which many networking devices are connected. It is usually located in one immediate area such as a building or floor of a building.

Use the LAN screens to help you configure a LAN DHCP server and manage IP addresses.

Figure 63 Home Networking Example



#### 8.1.1 What You Can Do in this Chapter

- Use the **Home Networking** screen to set the LAN IP address, subnet mask, and DHCP settings of your WX Device ([Section 8.2 on page 125](#)).

#### 8.1.2 What You Need To Know

##### 8.1.2.1 About LAN

###### IP Address

IP addresses identify individual devices on a network. Every networking device (including computers, servers, routers, printers, and so on) needs an IP address to communicate across the network. These networking devices are also known as hosts.

###### Subnet Mask

Subnet masks determine the maximum number of possible hosts on a network. You can also use subnet masks to divide one network into multiple sub-networks.

#### 8.1.3 Before You Begin

Find out the MAC addresses of your network devices if you intend to add them to the DHCP Client List screen.

## 8.2 Home Networking Screen

Use this screen to set the IP address and subnet mask of your WX Device. Configure DHCP settings to have a DHCP server assign IP addresses to devices. Click **Network Setting > Home Networking** to open the **Home Networking** screen.

Follow these steps to configure your LAN settings.

- 1 Enter an IP address into the **IP Address** field. The IP address must be in dotted decimal notation. This will become the IP address of your WX Device.
- 2 Enter the IP subnet mask into the **IP Subnet Mask** field. Unless instructed otherwise it is best to leave this alone, the configurator will automatically compute a subnet mask based upon the IP address you entered.
- 3 Click **Apply** to save your settings.

**Figure 64** Network Setting > Home Networking > Home Networking

The following table describes the fields in this screen.

**Table 31** Network Setting > Home Networking > LAN Setup

| LABEL        | DESCRIPTION  |
|--------------|--|
| LAN IP Setup | Select <b>DHCP</b> to deploy the WX Device as a DHCP client in the network. When you enable this, the WX Device gets its IP address from the network's DHCP server (for example, your ISP or router). Users connected to the WX Device can now access the network (i.e., the Internet if the IP address is given by the ISP or a router with Internet access). When you select this, you cannot enter an IP address for your WX Device in the field below.<br>Select <b>Static IP</b> if you want to specify the IP address of your WX Device. Or if your ISP or network administrator gave you a static IP address to access the network or the Internet. |
| IP Address   | Enter the LAN IPv4 IP address you want to assign to your WX Device in dotted decimal notation, for example, 192.168.1.2 (factory default).   |

Table 31 Network Setting &gt; Home Networking &gt; LAN Setup (continued)

| LABEL              | DESCRIPTION  |
|--------------------|--|
| Subnet Mask        | Type the subnet mask of your network in dotted decimal notation, for example 255.255.255.0 (factory default). Your WX Device automatically computes the subnet mask based on the IP address you enter, so do not change this field unless you are instructed to do so.   |
| Gateway IP Address | Enter a gateway IPv4 address (if your ISP or network administrator gave you one) in this field.  |
| IPv6 Setup         | <p>Select how you want to obtain an IPv6 address:</p> <p>Select <b>Stateful</b> to obtain an IPv6 address using IPv6 stateful autoconfiguration.</p> <p>Select <b>Stateless</b> to obtain an IPv6 address using IPv6 stateless autoconfiguration.</p> <p>Select <b>Static</b> to configure a fixed IPv6 address for the WX Device.</p> |
| WAN IPv6 Address   | Enter an IPv6 IP address that your ISP gave you for the WAN interface.   |
| IPv6 Gateway       | Enter the IP address of the next-hop gateway. The gateway is a router or switch on the same segment as your WX Device's interfaces. The gateway helps forward packets to their destinations.   |
| Cancel             | Click <b>Cancel</b> to restore the default or previously saved settings.   |
| Apply              | Click <b>Apply</b> to save your changes.   |

# CHAPTER 9

# Log

## 9.1 Log Overview

These screens allow you to determine the categories of events that the WX Device logs and then display these logs or have the WX Device send them to an administrator (through e-mail) or to a syslog server.

### 9.1.1 What You Can Do in this Chapter

- Use the **System Log** screen to see the system logs ([Section 9.2 on page 128](#)).

### 9.1.2 What You Need To Know

The following terms and concepts may help as you read this chapter.

#### Alerts and Logs

An alert is a type of log that warrants more serious attention. They include system errors, attacks (access control) and attempted access to blocked web sites. Some categories such as **System Errors** consist of both logs and alerts. You may differentiate them by their color in the **View Log** screen. Alerts display in red and logs display in black.

#### Syslog Overview

The syslog protocol allows devices to send event notification messages across an IP network to syslog servers that collect the event messages. A syslog-enabled device can generate a syslog message and send it to a syslog server.

Syslog is defined in RFC 3164. The RFC defines the packet format, content and system log related information of syslog messages. Each syslog message has a facility and severity level. The syslog facility identifies a file in the syslog server. Refer to the documentation of your syslog program for details. The following table describes the syslog severity levels.

Table 32 Syslog Severity Levels

| CODE | SEVERITY   |
|------|--|
| 0    | Emergency: The system is unusable.                                 |
| 1    | Alert: Action must be taken immediately.                           |
| 2    | Critical: The system condition is critical.                        |
| 3    | Error: There is an error condition on the system.                  |
| 4    | Warning: There is a warning condition on the system.               |
| 5    | Notice: There is a normal but significant condition on the system. |
| 6    | Informational: The syslog contains an informational message.       |
| 7    | Debug: The message is intended for debug-level purposes.           |

## 9.2 System Log Settings

Use the **Log** screen to see the system logs. You can filter the entries by selecting a severity level and/or category. Click **System Monitor > Log > System Log** to open the **System Log** screen.

**Figure 65** System Monitor > Log > System Log

The screenshot shows the 'Log' screen with a header and a table of log entries. The header includes a title 'Log', a descriptive text box, and filter controls for 'Level' (set to 'All') and 'Category' (set to 'All'). There are also buttons for 'Clear Log', 'Refresh', and 'Export Log'. The table below has columns for '#', 'Time', 'Facility', 'Level', 'Category', and 'Messages'. All entries in the table show a 'debug' level and 'dhcpc' category, with the message 'udhcpd: Sending discover...'. The times range from 10:37 to 12:21 on Jan 1.

| #  | Time           | Facility | Level | Category | Messages                    |
|----|----------------|----------|-------|----------|-----------------------------|
| 1  | Jan 1 02:12:21 | user     | debug | dhcpc    | udhcpd: Sending discover... |
| 2  | Jan 1 02:12:19 | user     | debug | dhcpc    | udhcpd: Sending discover... |
| 3  | Jan 1 02:12:10 | user     | debug | dhcpc    | udhcpd: Sending discover... |
| 4  | Jan 1 02:12:08 | user     | debug | dhcpc    | udhcpd: Sending discover... |
| 5  | Jan 1 02:12:04 | user     | debug | dhcpc    | udhcpd: Sending discover... |
| 6  | Jan 1 02:11:57 | user     | debug | dhcpc    | udhcpd: Sending discover... |
| 7  | Jan 1 02:11:55 | user     | debug | dhcpc    | udhcpd: Sending discover... |
| 8  | Jan 1 02:11:53 | user     | debug | dhcpc    | udhcpd: Sending discover... |
| 9  | Jan 1 02:11:44 | user     | debug | dhcpc    | udhcpd: Sending discover... |
| 10 | Jan 1 02:11:42 | user     | debug | dhcpc    | udhcpd: Sending discover... |
| 11 | Jan 1 02:11:40 | user     | debug | dhcpc    | udhcpd: Sending discover... |
| 12 | Jan 1 02:11:31 | user     | debug | dhcpc    | udhcpd: Sending discover... |
| 13 | Jan 1 02:11:29 | user     | debug | dhcpc    | udhcpd: Sending discover... |
| 14 | Jan 1 02:11:27 | user     | debug | dhcpc    | udhcpd: Sending discover... |
| 15 | Jan 1 02:11:18 | user     | debug | dhcpc    | udhcpd: Sending discover... |
| 16 | Jan 1 02:11:14 | user     | debug | dhcpc    | udhcpd: Sending discover... |
| 17 | Jan 1 02:11:14 | user     | debug | dhcpc    | udhcpd: Sending discover... |
| 18 | Jan 1 02:11:05 | user     | debug | dhcpc    | udhcpd: Sending discover... |
| 19 | Jan 1 02:11:03 | user     | debug | dhcpc    | udhcpd: Sending discover... |
| 20 | Jan 1 02:11:01 | user     | debug | dhcpc    | udhcpd: Sending discover... |
| 21 | Jan 1 02:10:52 | user     | debug | dhcpc    | udhcpd: Sending discover... |
| 22 | Jan 1 02:10:50 | user     | debug | dhcpc    | udhcpd: Sending discover... |
| 23 | Jan 1 02:10:48 | user     | debug | dhcpc    | udhcpd: Sending discover... |
| 24 | Jan 1 02:10:39 | user     | debug | dhcpc    | udhcpd: Sending discover... |
| 25 | Jan 1 02:10:37 | user     | debug | dhcpc    | udhcpd: Sending discover... |

The following table describes the fields in this screen.

**Table 33** System Monitor > Log > System Log

| LABEL      | DESCRIPTION   |
|------------|---|
| Level      | Select a severity level from the drop-down list box. This filters search results according to the severity level you have selected. When you select a severity, the WX Device searches through all logs of that severity or higher. |
| Category   | Select the type of logs to display.   |
| Clear Log  | Click this to delete all the logs.  |
| Refresh    | Click this to renew the log screen.   |
| Export Log | Click this to save the current list of logs to your computer.   |
| #          | This field is a sequential value and is not associated with a specific entry.   |
| Time       | This field displays the time the log was recorded.  |



Table 33 System Monitor &gt; Log &gt; System Log (continued)

| LABEL    | DESCRIPTION   |
|----------|---|
| Facility | The log facility allows you to send logs to different files in the syslog server. Refer to the documentation of your syslog program for more details. |
| Level    | This field displays the severity level of the log.  |
| Category | This field displays the type of the log.  |
| Messages | This field states the reason for the log.   |

# CHAPTER 10

## Multicast Status

### 10.1 Multicast Status Overview

Use the **Multicast Status** screens to view IPv4 or IPv6 multicast group information.

### 10.2 IGMP Status

Use this screen to look at the current list of IPv4 multicast groups the WX Device manages through IGMP. Internet Group Multicast Protocol (IGMP) is a network-layer protocol used to establish membership in a Multicast group - it is not used to carry user data. You can configure IGMP settings in **Network Setting > IGMP Status**.

**Figure 66** System Monitor > Multicast Status > IGMP Status

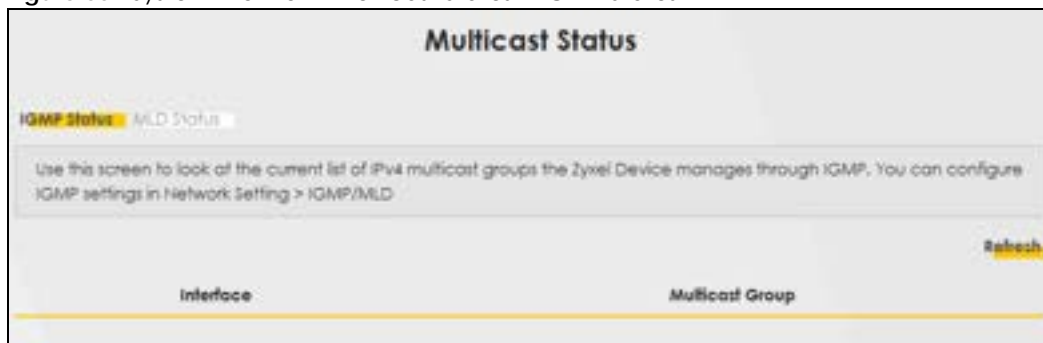

The following table describes the labels in this screen.

**Table 34** System Monitor > Multicast Status > IGMP Status

| LABEL           | DESCRIPTION  |
|-----------------|--|
| Refresh         | Click this button to update the information on this screen.  |
| Interface       | This field displays the name of the WX Device's interface that belongs to an IGMP multicast group. |
| Multicast Group | This field displays the address of the IGMP multicast group to which the interface belongs.        |

### 10.3 MLD Status

Use this screen to look at the current list of IPv6 multicast groups the WX Device manages through MLD. Multicast Listener Discovery (MLD) allows an IPv6 switch or router to discover the presence of MLD hosts who wish to receive multicast packets and the IP addresses of multicast groups the hosts want to join on its network. MLDv1 is equivalent to IGMPv2 and MLDv2 is equivalent to IGMPv3. You can configure MLD

settings in **Network Setting > MLD Status**. To open this screen, click **System Monitor > Multicast Status > MLD Status**.

**Figure 67** System Monitor > Multicast Status > MLD Status

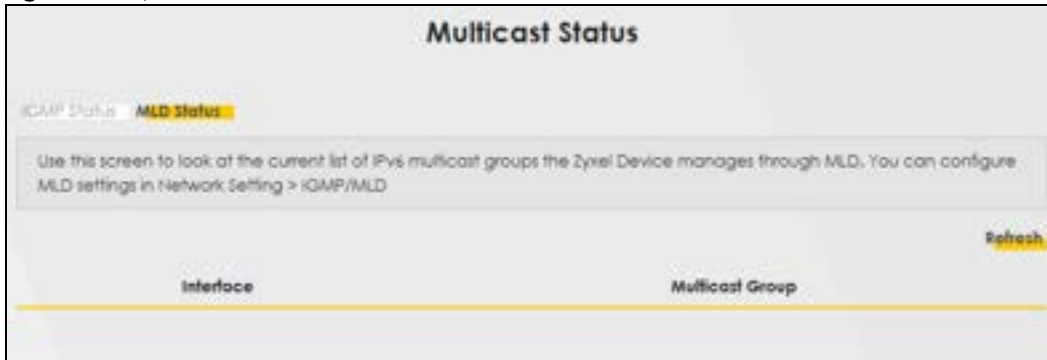

The following table describes the labels in this screen.

**Table 35** System Monitor > Multicast Status > MLD Status

| LABEL           | DESCRIPTION   |
|-----------------|---|
| Refresh         | Click this button to update the status on this screen.  |
| Interface       | This field displays the name of the WX Device's interface that belongs to an MLD multicast group. |
| Multicast Group | This field displays the address of the MLD multicast group to which the interface belongs.        |

# CHAPTER 11

## WLAN Station Status

### 11.1 WLAN Station Status Overview

Click **System Monitor > WLAN Station Status** to open the following screen. Use this screen to view information and status of the wireless stations (wireless clients) that are currently associated with the WX Device. Being associated means that a wireless client (for example, your computer with a wireless network card installed) has connected successfully to an AP (or wireless router) using the same SSID, channel, and WiFi security settings.

**Figure 68** System Monitor > WLAN Station Status

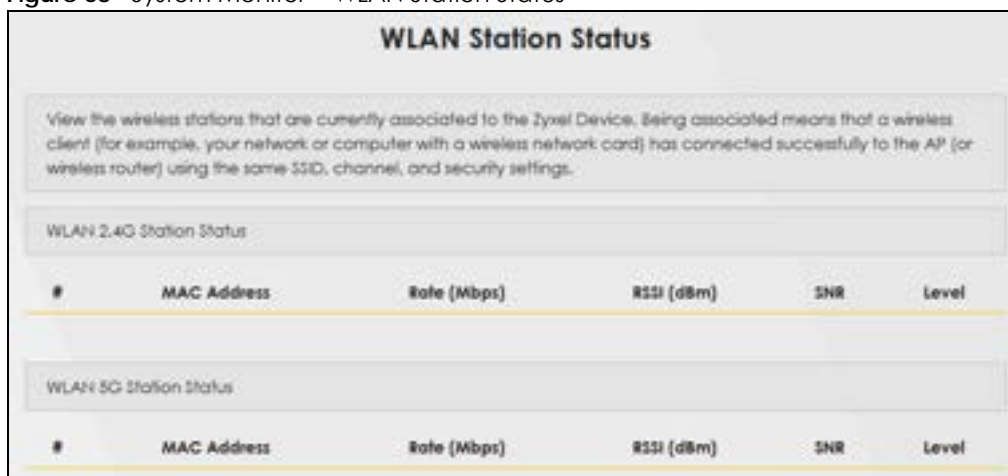

**WLAN Station Status**

View the wireless stations that are currently associated to the Zyxel Device. Being associated means that a wireless client (for example, your network or computer with a wireless network card) has connected successfully to the AP (or wireless router) using the same SSID, channel, and security settings.

WLAN 2.4G Station Status

| # | MAC Address | Rate (Mbps) | RSSI (dBm) | SNR | Level |
|---|-------------|-------------|------------|-----|-------|
|---|-------------|-------------|------------|-----|-------|

WLAN 5G Station Status

| # | MAC Address | Rate (Mbps) | RSSI (dBm) | SNR | Level |
|---|-------------|-------------|------------|-----|-------|
|---|-------------|-------------|------------|-----|-------|

The following table describes the labels in this screen.

**Table 36** System Monitor > WLAN Station Status

| LABEL       | DESCRIPTION  |
|-------------|--|
| #           | This is the index number of an associated wireless station.  |
| MAC Address | This field displays the MAC address of an associated wireless station.   |
| Rate (Mbps) | This field displays the transmission rate of WiFi traffic between an associated wireless station and the WX Device.  |
| RSSI (dBm)  | The RSSI (Received Signal Strength Indicator) field shows the WiFi signal strength of the station's wireless connection.<br><br>The normal range is -30dBm to -79dBm. If the value drops below -80dBm, try moving the associated wireless station closer to the WX Device to get better signal strength. |

Table 36 System Monitor &gt; WLAN Station Status (continued)

| LABEL | DESCRIPTION  |
|-------|--|
| SNR   | <p>The Signal-to-Noise Ratio (SNR) is the ratio between the received signal power and the received noise power.</p> <p>The normal range is 15 to 40. If the value drops below 15, try moving the associated wireless station closer to the WX Device to get better quality WiFi.</p>   |
| Level | <p>This field displays a number which represents the strength of the WiFi signal between an associated wireless station and the WX Device. The WX Device uses the RSSI and SNR values to determine the strength of the WiFi signal.</p> <p>5 means the WX Device is receiving an excellent WiFi signal.</p> <p>4 means the WX Device is receiving a very good WiFi signal.</p> <p>3 means the WX Device is receiving a weak WiFi signal.</p> <p>2 means the WX Device is receiving a very weak WiFi signal.</p> <p>1 means the WX Device is not receiving a WiFi signal.</p> |

# CHAPTER 12

## System

### 12.1 System Overview

In the **System** screen, you can name your WX Device (Host) and give it an associated domain name. Domain is the name given to a network. It will be required to reach a network from an external point (like the Internet). Knowing the domain name will allow you to reach a particular network, and knowing the host name will allow you to reach a particular device. For this reason, accessing a device from another device within a network may work with just the host name (without the use of the domain name).

### 12.2 System Settings

Click **Maintenance > System** to open the following screen. Assign a unique name to the WX Device so it can be easily recognized on your network. You can use up to 30 characters, including spaces.

**Figure 69** Maintenance > System

**System**

In the **System** screen, you can name your Zyxel Device (Host) and give it an associated domain name for identification purposes.

Assign a unique name to the Zyxel Device so it can be easily recognized on your network. You can use up to 30 characters, including spaces.

Host Name:

Cancel Apply

The following table describes the labels in this screen.

**Table 37** Maintenance > System

| LABEL     | DESCRIPTION   |
|-----------|---|
| Host Name | Type a host name for your WX Device. Enter a descriptive name of up to 16 alphanumeric characters, not including spaces, underscores, and dashes. |
| Cancel    | Click <b>Cancel</b> to restore the default or previously saved settings.  |
| Apply     | Click <b>Apply</b> to save your changes.  |

# CHAPTER 13

## User Account

### 13.1 User Account Overview

In the **User Account** screen, you can view the settings of the 'admin' and other user accounts that you use to log into the WX Device to manage it.

### 13.2 User Account Settings

Click **Maintenance > User Account** to open the following screen. Use this screen to create or manage user accounts and their privileges on the WX Device.

**Figure 70** Maintenance > User Account

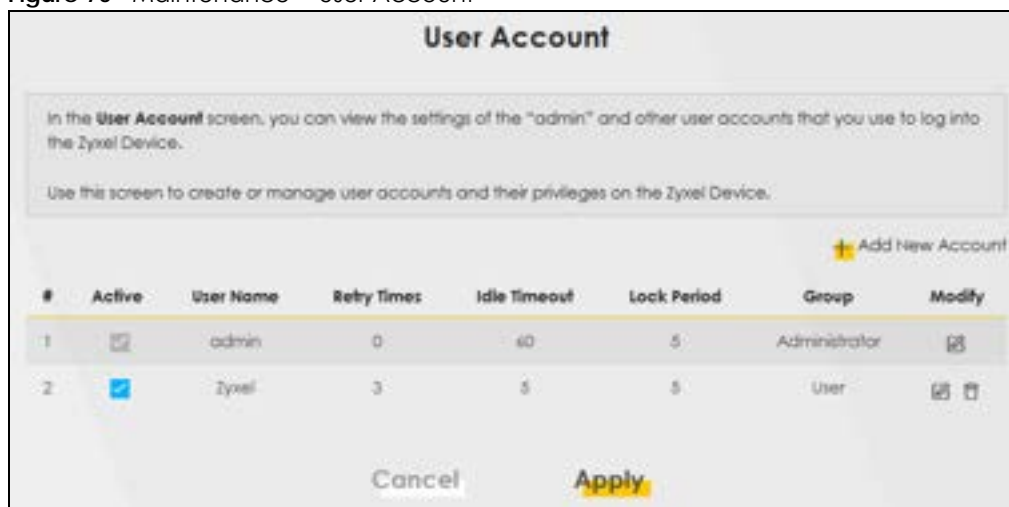

The following table describes the labels in this screen.

**Table 38** Maintenance > User Account

| LABEL           | DESCRIPTION  |
|-----------------|--|
| Add New Account | Click this button to add a new user account.   |
| #               | This is the index number of the user account.  |
| Active          | This field indicates whether the user account is active or not.<br>Clear the check box to disable the user account. Select the check box to enable it. |
| User Name       | This field displays the name of the account used to log into the WX Device Web Configurator.   |
| Retry Times     | This field displays the number of times consecutive wrong passwords can be entered for this account. 0 means there is no limit.                        |

Table 38 Maintenance &gt; User Account (continued)

| LABEL        | DESCRIPTION  |
|--------------|--|
| Idle Timeout | This field displays the length of inactive time before the WX Device will automatically log the user out of the Web Configurator.  |
| Lock Period  | This field displays the length of time a user must wait before attempting to log in again after a number if consecutive wrong passwords have been entered as defined in <b>Retry Times</b> . |
| Group        | This field displays whether this user has <b>Administrator</b> or <b>User</b> privileges.  |
| Modify       | Click the <b>Edit</b> icon to configure the entry.<br>Click the <b>Delete</b> icon to remove the entry.  |
| Cancel       | Click <b>Cancel</b> to restore the default or previously saved settings.   |
| Apply        | Click <b>Apply</b> to save your changes.   |

### 13.2.1 User Account Add/Edit

Click **Add New Account** or the **Edit** icon of an existing account in the **Maintenance > User Account** to open the following screen.

Figure 71 Maintenance &gt; User Account &gt; Add/Edit

The following table describes the labels in this screen.

Table 39 Maintenance &gt; User Account &gt; Add/Edit

| LABEL           | DESCRIPTION  |
|-----------------|--|
| Active          | Select <b>Enable</b> or <b>Disable</b> to activate or deactivate the user account.   |
| User Name       | Enter a new name for the account. The <b>User Name</b> must contain 1 to 15 characters, including 0 to 9, a to z, and !@#%*()-_+=~.,{} \. Spaces are not allowed.  |
| Password        | Type your new system password. The <b>Password</b> must contain 6 to 64 characters, including 0 to 9 and a to z. Note that as you type a password, the screen displays a (*) for each character you type. After you change the password, use the new password to access the WX Device. |
| Verify Password | Type the new password again for confirmation.  |



Table 39 Maintenance &gt; User Account &gt; Add/Edit (continued)

| LABEL        | DESCRIPTION   |
|--------------|---|
| Retry Times  | Enter the number of times consecutive wrong passwords can be entered for this account. 0 means there is no limit.   |
| Idle Timeout | Enter the length of inactive time before the WX Device will automatically log the user out of the Web Configurator.   |
| Lock Period  | Enter the length of time a user must wait before attempting to log in again after a number of consecutive wrong passwords have been entered as defined in <b>Retry Times</b> .  |
| Group        | Specify whether this user will have <b>Administrator</b> or <b>User</b> privileges. <b>Administrator</b> and <b>User</b> privileges are mostly the same, but the following menu items will only display when you log in as an <b>Administrator</b> . <ul style="list-style-type: none"><li>• <b>Network Setting</b></li><li>• <b>Security Settings</b></li><li>• <b>Maintenance &gt; System</b></li></ul> |
| Cancel       | Click <b>Cancel</b> to exit this screen without saving any changes.   |
| OK           | Click <b>OK</b> to save your changes.   |

# CHAPTER 14

## Remote Management

### 14.1 Remote Management Overview

Use remote management to control what services you can use through which interface(s) in order to manage the WX Device.

#### 14.1.1 What You Can Do in this Chapter

- Use the **Remote Management** screen to allow various approaches to access the WX Device remotely from a LAN connection ([Section 14.2 on page 138](#)).

Note: The WX Device is managed using the Web Configurator.

### 14.2 MGMT Services

Use this screen to configure through which interface(s), each service can access the WX Device. You can also specify service port numbers computers must use to connect to the WX Device. Click **Maintenance > Remote Management > Remote Management** to open the following screen.

**Figure 72** Maintenance > Remote Management > Remote Management

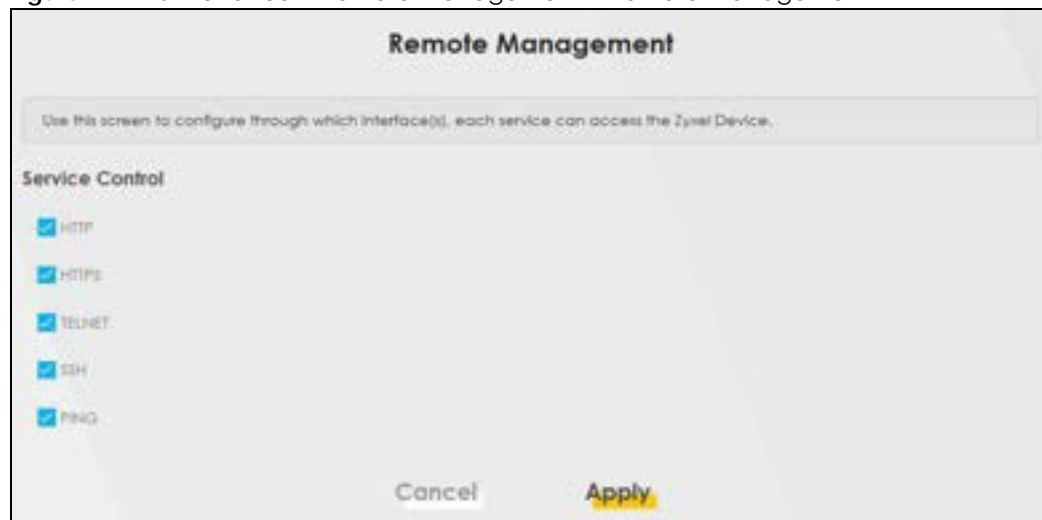

The following table describes the fields in this screen.

Table 40 Maintenance > Remote Management > Remote Management

| LABEL   | DESCRIPTION   |
|---------|---|
| Service | This is the service list you may use to access the WX Device. <ul style="list-style-type: none"><li>• <b>HTTP</b> provides a non secured way.</li><li>• <b>HTTPS</b> is the secured version of HTTP, it makes sure that your data cannot be read during transmission.</li><li>• <b>TELNET</b> provides a way to control your WX Device remotely.</li><li>• <b>SSH</b> prevents leakage of data during remote management. Additionally, it can encrypt all transmitted data.</li><li>• <b>PING</b> is a diagnostic tool that can check if your WX Device is connected to the Internet.</li></ul> |
| Cancel  | Click <b>Cancel</b> to restore the default or previously saved settings.  |
| Apply   | Click <b>Apply</b> to save your changes back to the WX Device.  |

# CHAPTER 15

## Time Settings

### 15.1 Time Settings Overview

This chapter shows you how to configure the WX Device's system date and time.

### 15.2 Time

For effective scheduling and logging, the WX Device's system time must be accurate. Use this screen to configure the WX Device's time based on your local time zone. You can enter a time server address, select the time zone where the WX Device is physically located, and configure Daylight Savings settings if needed.

Click **Maintenance** > **Time** to open the following screen.

Figure 73 Maintenance &gt; Time

The following table describes the fields in this screen.

Table 41 Maintenance &gt; Time

| LABEL                             | DESCRIPTION   |
|-----------------------------------|---|
| Current Date/Time                 |   |
| Current Time                      | This field displays the time of your WX Device.<br>Each time you reload this page, the WX Device synchronizes the time with the time server.  |
| Current Date                      | This field displays the date of your WX Device.<br>Each time you reload this page, the WX Device synchronizes the date with the time server.  |
| Time and Date Setup               |   |
| First ~ Fifth Time Server Address | Select an NTP time server from the drop-down list box.<br>Otherwise, select <b>Other</b> and enter the IP address or URL (up to 29 extended ASCII characters in length) of your time server.<br>Select <b>None</b> if you do not want to configure the time server.<br>Check with your ISP/network administrator if you are unsure of this information. |
| Time Zone                         |   |

Table 41 Maintenance &gt; Time (continued)

| LABEL            | DESCRIPTION  |
|------------------|--|
| Time Zone        | Choose the time zone of your location. This will set the time difference between your time zone and Greenwich Mean Time (GMT).   |
| Daylight Savings | Daylight Saving Time is a period from late spring to early fall when many countries set their clocks ahead of normal local time by one hour to give more daytime light in the evening.   |
| Active           | Click this switch to enable or disable Daylight Saving Time. When the switch goes to the right  , the function is enabled. Otherwise, it is not.  |
| Start Rule       | <p>Configure the day and time when Daylight Saving Time starts if you enabled Daylight Saving. You can select a specific date in a particular month or a specific day of a specific week in a particular month. The <b>Hour</b> field uses the 24 hour format. Here are a couple of examples:</p> <p>Daylight Saving Time starts in most parts of the United States on the second Sunday of March. Each time zone in the United States starts using Daylight Saving Time at 2 A.M. local time. So in the United States, set the day to <b>Second, Sunday</b>, the month to <b>March</b> and the time to <b>2</b> in the <b>Hour</b> field.</p> <p>Daylight Saving Time starts in the European Union on the last Sunday of March. All of the time zones in the European Union start using Daylight Saving Time at the same moment (1 A.M. GMT or UTC). So in the European Union you would set the day to <b>Last, Sunday</b> and the month to <b>March</b>. The time you select in the <b>o'clock</b> field depends on your time zone. In Germany for instance, you would select <b>2</b> in the <b>Hour</b> field because Germany's time zone is one hour ahead of GMT or UTC (GMT+1).</p> |
| End Rule         | <p>Configure the day and time when Daylight Saving Time ends if you enabled Daylight Saving. You can select a specific date in a particular month or a specific day of a specific week in a particular month. The <b>Hour</b> field uses the 24 hour format. Here are a couple of examples:</p> <p>Daylight Saving Time ends in the United States on the first Sunday of November. Each time zone in the United States stops using Daylight Saving Time at 2 A.M. local time. So in the United States you would set the day to <b>First, Sunday</b>, the month to <b>November</b> and the time to <b>2</b> in the <b>Hour</b> field.</p> <p>Daylight Saving Time ends in the European Union on the last Sunday of October. All of the time zones in the European Union stop using Daylight Saving Time at the same moment (1 A.M. GMT or UTC). So in the European Union you would set the day to <b>Last, Sunday</b>, and the month to <b>October</b>. The time you select in the <b>o'clock</b> field depends on your time zone. In Germany for instance, you would select <b>2</b> in the <b>Hour</b> field because Germany's time zone is one hour ahead of GMT or UTC (GMT+1).</p>     |
| Cancel           | Click <b>Cancel</b> to restore the default or previously saved settings.   |
| Apply            | Click <b>Apply</b> to save your changes.   |

# CHAPTER 16

## Firmware Upgrade

### 16.1 Firmware Upgrade Overview

This screen lets you upload new firmware to your WX Device. You can download new firmware releases from your nearest Zyxel FTP site (or [www.zyxel.com](http://www.zyxel.com)) to upgrade your device's performance.

**Only use firmware for your device's specific model. Refer to the label on the bottom of your WX Device.**

### 16.2 Firmware Upgrade Settings

Click **Maintenance > Firmware Upgrade** to open the following screen. Download the latest firmware file from the Zyxel website and upload it to your WX Device using this screen. The upload process uses HTTP (Hypertext Transfer Protocol) and may take up to two minutes. After a successful upload, the WX Device will reboot.

**Do NOT turn off the WX Device while firmware upload is in progress!**

Figure 74 Maintenance > Firmware Upgrade

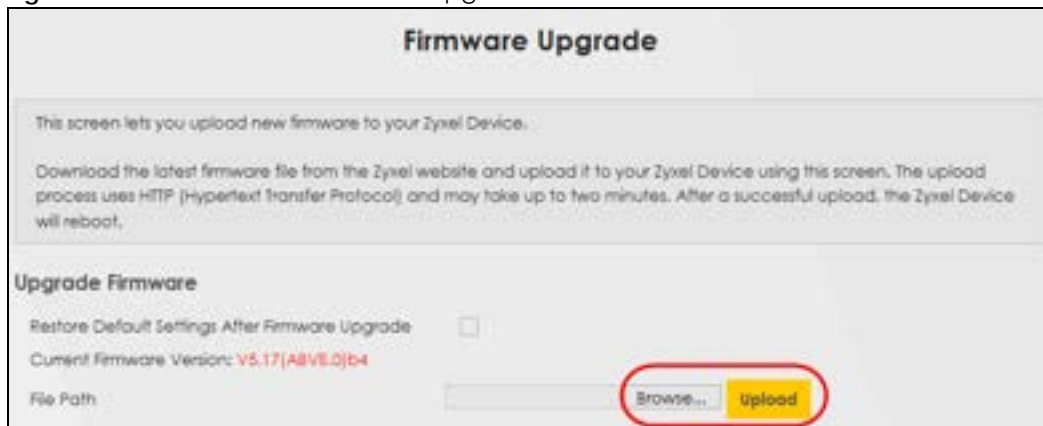

The screenshot shows a web interface titled "Firmware Upgrade". At the top, there is a heading "Firmware Upgrade". Below the heading, there is a text box containing the following instructions: "This screen lets you upload new firmware to your Zyxel Device. Download the latest firmware file from the Zyxel website and upload it to your Zyxel Device using this screen. The upload process uses HTTP (Hypertext Transfer Protocol) and may take up to two minutes. After a successful upload, the Zyxel Device will reboot." Below the text box, there is a section titled "Upgrade Firmware". In this section, there is a checkbox labeled "Restore Default Settings After Firmware Upgrade" which is currently unchecked. Below the checkbox, the current firmware version is displayed as "Current Firmware Version: v5.17(A8V6.0)64". At the bottom of the section, there is a "File Path" label followed by a text input field. To the right of the input field, there are two buttons: a "Browse..." button and a yellow "upload" button. A red oval highlights the "Browse..." and "upload" buttons.

The following table describes the labels in this screen. After you see the firmware updating screen, wait two minutes before logging into the WX Device again.

Table 42 Maintenance > Firmware Upgrade

| LABEL   | DESCRIPTION  |
|---|--|
| Upgrade Firmware                                |  |
| Restore Default Settings After Firmware Upgrade | Select the check box to have the WX Device automatically reset itself after the new firmware is uploaded.                                  |
| Current Firmware Version                        | This is the present Firmware version and the date created.   |
| File Path                                       | Type the location of the file you want to upload in this field or click <b>Browse</b> to find it.  |
| Browse  | Click this to find the .bin file you want to upload. Remember that you must decompress compressed (.zip) files before you can upload them. |
| Upload  | Click this to begin the upload process. This process may take up to two minutes.   |

Figure 75 Firmware Uploading

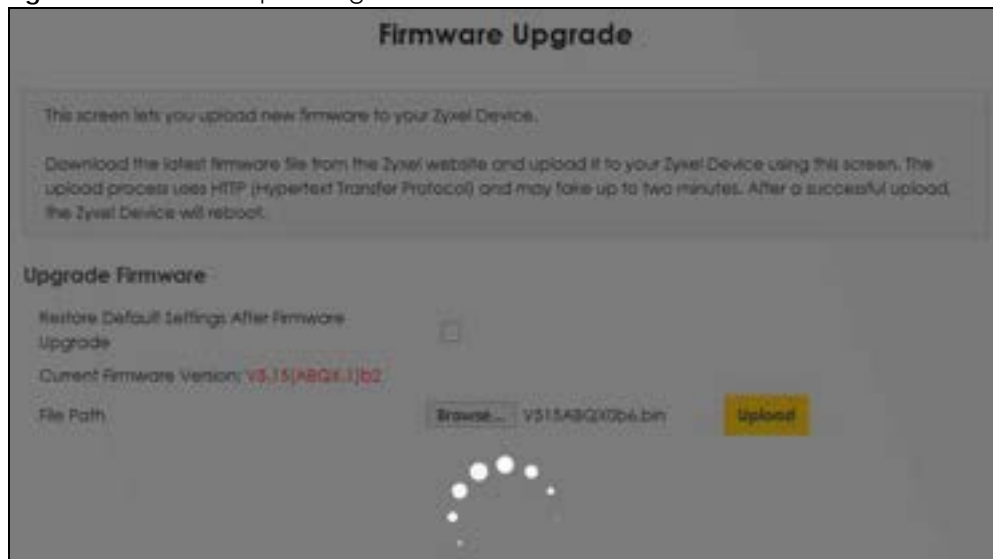

After two minutes, log in again and check your new firmware version in the **Status** screen.

If the upload was not successful, the following screen will appear. Click **OK** to go back to the **Firmware Upgrade** screen.

Figure 76 Error Message





Note that the WX Device automatically restarts during the upload, causing a temporary network disconnect. In some operating systems, you may see the following icon on your desktop.

Network Temporarily Disconnected



# CHAPTER 17

## Backup/Restore

### 17.1 Backup/Restore Overview

The **Backup/Restore** screen allows you to backup and restore device configurations. You can also reset your device settings back to the factory default.

### 17.2 Backup/Restore Settings

Click **Maintenance > Backup/Restore**. Information related to factory default settings and backup configuration are shown in this screen. You can also use this to restore previous device configurations.

**Figure 77** Maintenance > Backup/Restore

**Backup/Restore**

Information related to factory default settings and backup configuration are shown in this screen. You can also use this to restore previous device configurations.

Backup Configuration allows you to back up (save) the Zyxel Device's current configuration to a file on your computer. Once your Zyxel Device is configured and functioning properly, it is highly recommended that you back up your configuration file before making configuration changes.

Restore Configuration allows you to upload a new or previously saved configuration file from your computer to your Zyxel Device.

**Backup Configuration**

Click Backup to save the current configuration of your system to your computer.

**Backup**

**Restore Configuration**

To restore a previously saved configuration file to your system, browse to the location of the configuration file and click Upload.

File Path:

**Back to Factory Default Settings**

Click Reset to clear all user-entered configuration information and return to factory default settings. After resetting, the

- Password is printed on a label on the bottom of the device, written after the text "Password".
- LAN IP address will be 192.168.1.2

**Reset**

## Backup Configuration

Backup Configuration allows you to back up (save) the WX Device's current configuration to a file on your computer. Once your WX Device is configured and functioning properly, it is highly recommended that you back up your configuration file before making configuration changes. The backup configuration file will be useful in case you need to return to your previous settings.

Click **Backup** to save the WX Device's current configuration to your computer.

## Restore Configuration

Restore Configuration allows you to upload a new or previously saved configuration file from your computer to your WX Device.

Table 43 Restore Configuration

| LABEL     | DESCRIPTION   |
|-----------|---|
| File Path | Type in the location of the file you want to upload in this field or click <b>Browse</b> to find it.                                  |
| Browse    | Click this to find the file you want to upload. Remember that you must decompress compressed (.ZIP) files before you can upload them. |
| Upload    | Click this to begin the upload process.   |

**Do NOT turn off the WX Device while configuration file upload is in progress.**

After the WX Device configuration has been restored successfully, the login screen appears. Login again to restart the WX Device.

The WX Device automatically restarts in this time causing a temporary network disconnect. In some operating systems, you may see the following icon on your desktop.

Figure 78 Network Temporarily Disconnected



If you uploaded the default configuration file you may need to change the IP address of your computer to be in the same subnet as that of the default device IP address (192.168.1.2).

If the upload was not successful, the following screen will appear. Click **OK** to go back to the **Backup/Restore** screen.

Figure 79 Configuration Upload Error

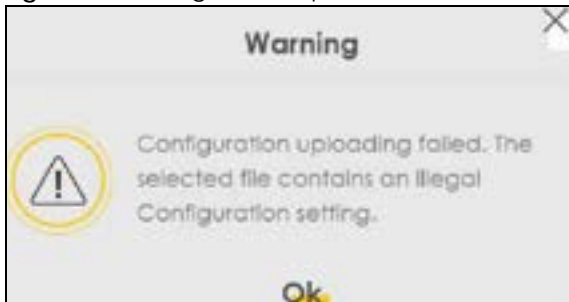

## Reset to Factory Defaults

Click the **Reset** button to clear all user-entered configuration information and return the WX Device to its factory defaults. The following warning screen appears.

**Figure 80** Reset Warning Message

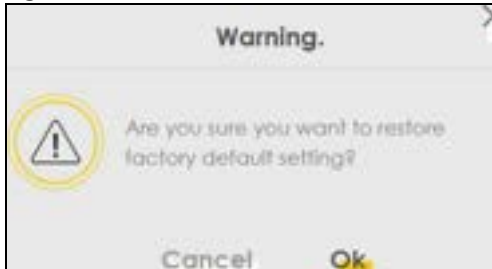

**Figure 81** Reset In Process Message

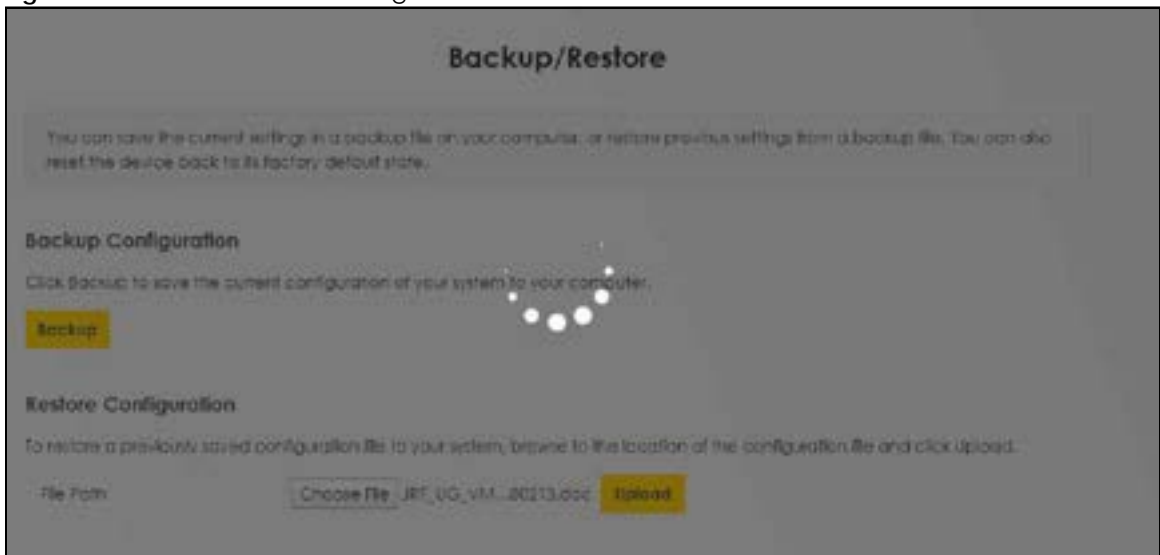

You can also press the **RESET** button on the rear panel to reset the factory defaults of your WX Device. Refer to [Section 2.6 on page 29](#) for more information on the **RESET** button.

## 17.3 Reboot

System Reboot allows you to reboot the WX Device remotely without turning the power off. You may need to do this if the WX Device hangs, for example.

Click **Maintenance > Reboot**. Click **Reboot** to have the WX Device reboot. This does not affect the WX Device's configuration.

**Figure 82** Maintenance > Reboot

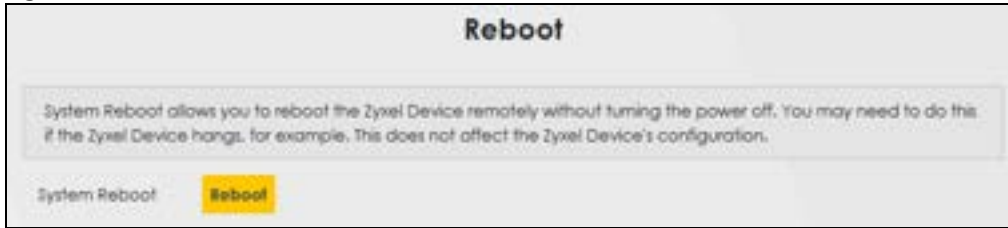

# CHAPTER 18

## Diagnostic

### 18.1 Diagnostic Overview

The **Diagnostic** screens display information to help you identify problems with the WX Device.

The route between a Central Office Very-high-bit-rate Digital Subscriber Line (CO VDSL) switch and one of its Customer-Premises Equipment (CPE) may go through switches owned by independent organizations. A connectivity fault point generally takes time to discover and impacts subscriber's network access. In order to eliminate the management and maintenance efforts, IEEE 802.1ag is a Connectivity Fault Management (CFM) specification which allows network administrators to identify and manage connection faults. Through discovery and verification of the path, CFM can detect, analyze and isolate connectivity faults in bridged LANs.

#### 18.1.1 What You Can Do in this Chapter

- The **Ping & TraceRoute** screen lets you ping an IP address or trace the route packets take to a host ([Section 18.3 on page 151](#)).

### 18.2 What You Need to Know

The following terms and concepts may help as you read through this chapter.

#### How CFM Works

A Maintenance Association (MA) defines a VLAN and associated Maintenance End Point (MEP) ports on the device under a Maintenance Domain (MD) level. An MEP port has the ability to send Connectivity Check Messages (CCMs) and get other MEP ports information from neighbor devices' CCMs within an MA.

CFM provides two tests to discover connectivity faults.

- Loopback test - checks if the MEP port receives its Loop Back Response (LBR) from its target after it sends the Loop Back Message (LBM). If no response is received, there might be a connectivity fault between them.
- Link trace test - provides additional connectivity fault analysis to get more information on where the fault is. If an MEP port does not respond to the source MEP, this may indicate a fault. Administrators can take further action to check and resume services from the fault according to the line connectivity status report.

## 18.3 Ping & TraceRoute

Use this screen use ping, traceroute, or nslookup for troubleshooting. Ping and traceroute are used to test whether a particular host is reachable. After entering an IP address and clicking on one of the buttons to start a test, the results will be shown in the Ping/Traceroute Test area. Use nslookup to find the IP address for a host name and vice versa. Click **Maintenance > Diagnostic** to open the screen shown next.

**Figure 83** Maintenance > Diagnostic

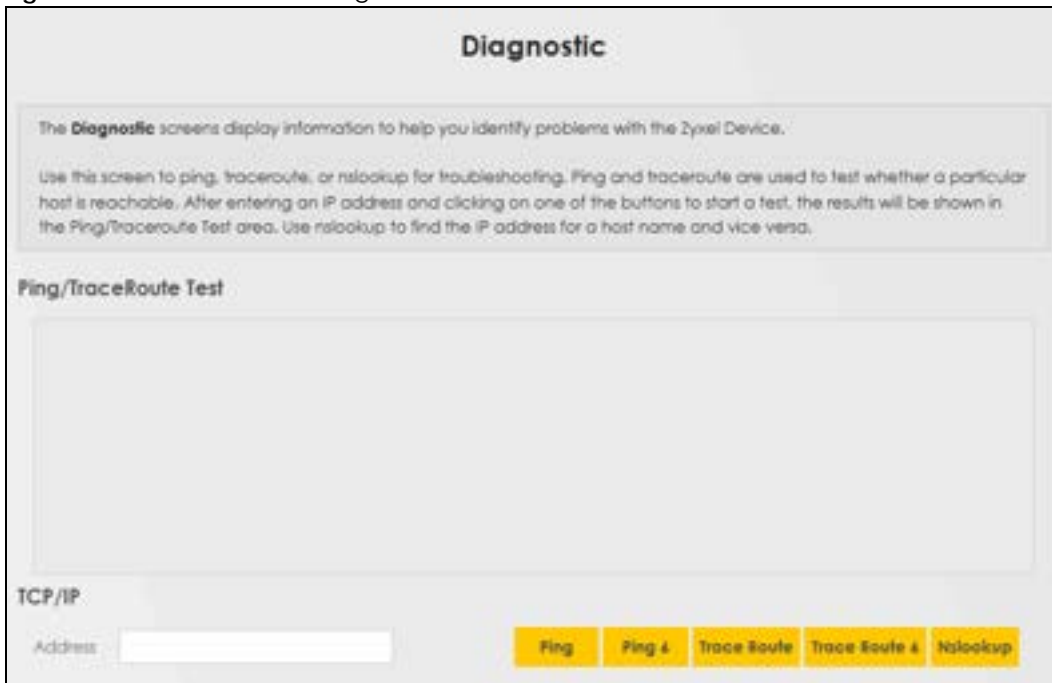

The following table describes the fields in this screen.

**Table 44** Maintenance > Diagnostic

| LABEL         | DESCRIPTION  |
|---------------|--|
| Address       | Type the IP address of a computer that you want to perform ping, traceroute, or nslookup in order to test a connection.  |
| Ping          | Click this to ping the IPv4 address that you entered.  |
| Ping 6        | Click this to ping the IPv6 address that you entered.  |
| Trace Route   | Click this to display the route path and transmission delays between the WX Device to the IPv4 address that you entered. |
| Trace Route 6 | Click this to display the route path and transmission delays between the WX Device to the IPv6 address that you entered. |
| Nslookup      | Click this button to perform a DNS lookup on the IP address of a computer you enter.                                     |

---

# PART III

## Troubleshooting and Appendices

---

Appendices contain general information. Some information may not apply to your WX Device.



# CHAPTER 19

# Troubleshooting

This chapter offers some suggestions to solve problems you might encounter. The potential problems are divided into the following categories.

- [Power and Hardware Problems](#)
- [Device Access Problems](#)
- [Internet Problems](#)
- [WiFi Problems](#)
- [Resetting the WX Device to Its Factory Defaults](#)
- [MPro Mesh App Problems](#)
- [Daisy Chain Problems](#)

## 19.1 Power and Hardware Problems

---

[The WX Device does not turn on. None of the LEDs turn on.](#)

---

- 1 Make sure the WX Device is turned on.
- 2 Make sure you are using the power adapter included with the WX Device.
- 3 Make sure the power adapter is connected to the WX Device and plugged in to an appropriate power source. Make sure the power source is turned on.
- 4 Turn the WX Device off and on.
- 5 If the problem continues, contact the vendor.

---

[One of the LEDs does not behave as expected.](#)

---

- 1 Make sure you understand the normal behavior of the LED. See [Table 12 on page 43](#).
- 2 Check the hardware connections.
- 3 Inspect your cables for damage. Contact the vendor to replace any damaged cables.
- 4 Turn the WX Device off and on.

- 5 If the problem continues, contact the vendor.

## 19.2 Device Access Problems

---

### I don't know the IP address of the WX Device.

---

- 1 The default LAN IP address is 192.168.1.2.
  - 2 If your router assigns an IP address to the WX Device, you can find your new IP address on the **Gateway Detail** screen using the MPro Mesh App (See [Section 4.5.1 on page 63](#) for more information) or log into your router's Web Configurator.
  - 3 If this does not work, you have to reset the device to its factory defaults. See [Section 19.5 on page 156](#).
- 

### I forgot the admin password.

---

- 1 See the cover page for the default login names and associated passwords.
  - 2 If those do not work, you have to reset the device to its factory defaults. See [Section 19.5 on page 156](#).
- 

### I cannot access the Web Configurator screen.

---

- 1 Make sure you are using the correct IP address.
    - The default IP address is [192.168.1.2](#). See [Chapter 3 on page 30](#) for more details.
    - If you changed the IP address (See [Section 8.2 on page 125](#)), use the new IP address.
    - If you changed the IP address and have forgotten it, see the troubleshooting suggestions for [I don't know the IP address of the WX Device](#).
    - Make sure your computer has an IP address in the same subnet as the WX Device. Your computer should have an IP address from 192.168.1.3 to 192.168.1.254. See [Section 19.5 on page 156](#).
  - 2 Check the hardware connections, and make sure the LEDs are behaving as expected. See [Table 12 on page 43](#).
  - 3 Make sure your Internet browser does not block pop-up windows and has JavaScripts and Java enabled.
  - 4 If it is possible to log in from another interface, check the service control settings for HTTP and HTTPS (**Maintenance > Remote Management**).
  - 5 Reset the device to its factory defaults, and try to access the WX Device with the default IP address. See [Section 19.5 on page 156](#).
-

- 6 If the problem continues, contact the network administrator or vendor, or try one of the advanced suggestions.

#### Advanced Suggestions

- Make sure you have logged out of any earlier management sessions using the same user account even if they were through a different interface or using a different browser.

---

#### I cannot log into the WX Device.

---

- 1 Make sure you have entered the password correctly. See the cover page for the default login names and associated passwords. The field is case-sensitive, so make sure [Caps Lock] is not on.
- 2 You cannot log in to the Web Configurator while someone is using Telnet to access the WX Device. Log out of the WX Device in the other session, or ask the person who is logged in to log out.
- 3 Turn the WX Device off and on.
- 4 If this does not work, you have to reset the device to its factory defaults. See [Section 19.5 on page 156](#).

## 19.3 Internet Problems

---

#### I cannot access the Internet.

---

- 1 Check the hardware connections and follow the instructions at [Section 4.3 on page 38](#) depending on if you choose to use a wired or a wireless connection. Make sure the LEDs are behaving as expected. See the **Quick Start Guide** and [Table 12 on page 43](#).
- 2 Make sure you entered your ISP account information correctly in the **Network Setting > Home Networking** screen. These fields are case-sensitive, so make sure [Caps Lock] is not on.
- 3 If you are trying to access the Internet wirelessly, make sure that you enable WiFi on the WX Device (the WX Device's WiFi is enabled by default) and your WiFi client, and that the WiFi settings in the WiFi client are the same as the settings in the WX Device. (see [Section 7.3 on page 98](#) for more information)
- 4 Disconnect all the cables from your device and reconnect them.
- 5 If the problem continues, contact your ISP.

---

#### I cannot connect to the Internet using an Ethernet cable.

---

- Make sure you have the Ethernet LAN port connected to a Modem or Router. (see [Section 4.3.2 on page 43](#) for more information)

## 19.4 WiFi Problems

---

### The WiFi connection is slow and intermittent.

---

The following factors may cause interference:

- Obstacles: walls, ceilings, furniture, and so on.
- Building Materials: metal doors, aluminum studs.
- Electrical devices: microwaves, monitors, electric motors, cordless phones, and other wireless devices.

To optimize the speed and quality of your WiFi connection, you can:

- Move your wireless device closer to the AP if the signal strength is low.
- Reduce wireless interference that may be caused by other WiFi networks or surrounding wireless electronics such as cordless phones.
- Place the AP where there are minimum obstacles (such as walls and ceilings) between the AP and the WiFi client.
- Reduce the number of WiFi clients connecting to the same AP simultaneously, or add additional APs if necessary.
- Try closing some programs that use the Internet, especially peer-to-peer applications. If the WiFi client is sending or receiving a lot of information, it may have too many programs open that use the Internet.

### I cannot access the WX Device using WiFi.

---

- Make sure the WX Device is working in AP or Repeater mode and the wireless LAN is enabled on the WX Device.
- Make sure the wireless adapter on the WiFi client is working properly.
- Make sure the wireless adapter installed on your computer is IEEE 802.11 compatible and supports the same wireless standard as the WX Device.
- Make sure your computer (with a wireless adapter installed) is within the transmission range of the WX Device.
- Check that both the WX Device and your wireless station are using the same WiFi and WiFi security settings.

## 19.5 Resetting the WX Device to Its Factory Defaults

If you reset the WX Device, you lose all of the changes you have made. The WX Device re-loads its default settings, and the password resets to the back-label default key. You have to make all of your changes again.

---

You will lose all of your changes when you reset the WX Device to its factory defaults.

---

- You can back up the configuration you made before resetting the WX Device.

To reset the WX Device,

- Make sure the power LED is on.
- Press the **RESET** button for longer than 5 seconds, the Power LED begins to blink, to set the WX Device back to its factory-default configuration.

OR

Click **Maintenance > Restore** and then click **Reset**.

- If the WX Device restarts automatically, wait for the WX Device to finish restarting, and log in to the Web Configurator. The password is in the device label.

If the WX Device does not restart automatically, disconnect and reconnect the WX Device. Then, follow the directions above again.

- You can upload a previously saved configuration file from your computer to the WX Device after resetting the device.

## 19.6 MPro Mesh App Problems

---

I cannot use the MPro Mesh app to manage my WiFi network.

---

- Make sure you connect your mobile device to the controller (The Zyxel MPro Mesh Router in **Scenario 1** or the WX Device-1 in **Scenario 2**) in order to manage the WiFi network.
- Make sure you use the controller's (The Zyxel MPro Mesh Router in **Scenario 1** or the WX Device-1 in **Scenario 2**) SSID and key when logging in with the app.

## 19.7 Daisy Chain Problems

---

I cannot add another WX Device to my daisy chain network.

---

- Check your device mode. The mode of your WX Device will affect how you add another WX Device to your network. For more information on modes, see [Section 1.1 on page 11](#). For more information on how to set your device in AP or Repeater mode, see [Section 1.1.2 on page 12](#).
- If you are using the WPS PBC (Push Button Configuration) method, make sure you press the WPS button in the right way. For more information on adding WX Devices using WPS button, see [Section 2.5.1 on page 28](#).
- If you are using the MPro Mesh app for adding a WX Device to your network, make sure you choose the right scenario.

With an MPro Mesh Router, follow the steps in **Scenario 1** to add WX Devices to your network (see [Section 4.3.1 on page 38](#) for more information).

With a non-MPro Mesh Router, follow the steps in **Scenario 2** to add WX Devices to your network (see [Section 4.3.2 on page 43](#) for more information)

# APPENDIX A

## Customer Support

In the event of problems that cannot be solved by using this manual, you should contact your vendor. If you cannot contact your vendor, then contact a Zyxel office for the region in which you bought the device.

See <https://www.zyxel.com/homepage.shtml> and also [https://www.zyxel.com/about\\_zyxel/zyxel\\_worldwide.shtml](https://www.zyxel.com/about_zyxel/zyxel_worldwide.shtml) for the latest information.

Please have the following information ready when you contact an office.

### Required Information

- Product model and serial number.
- Warranty Information.
- Date that you received your device.
- Brief description of the problem and the steps you took to solve it.

### Corporate Headquarters (Worldwide)

#### Taiwan

- Zyxel Communications Corporation
- <http://www.zyxel.com>

### Asia

#### China

- Zyxel Communications (Shanghai) Corp.
- Zyxel Communications (Beijing) Corp.
- Zyxel Communications (Tianjin) Corp.
- <https://www.zyxel.com/cn/zh/>

#### India

- Zyxel Technology India Pvt Ltd
- <https://www.zyxel.com/in/en/>

#### Kazakhstan

- Zyxel Kazakhstan
- <https://www.zyxel.kz>

## **Korea**

- Zyxel Korea Corp.
- <http://www.zyxel.kr>

## **Malaysia**

- Zyxel Malaysia Sdn Bhd.
- <http://www.zyxel.com.my>

## **Pakistan**

- Zyxel Pakistan (Pvt.) Ltd.
- <http://www.zyxel.com.pk>

## **Philippines**

- Zyxel Philippines
- <http://www.zyxel.com.ph>

## **Singapore**

- Zyxel Singapore Pte Ltd.
- <http://www.zyxel.com.sg>

## **Taiwan**

- Zyxel Communications Corporation
- <https://www.zyxel.com/tw/zh/>

## **Thailand**

- Zyxel Thailand Co., Ltd
- <https://www.zyxel.com/th/th/>

## **Vietnam**

- Zyxel Communications Corporation-Vietnam Office
- <https://www.zyxel.com/vn/vi>

## **Europe**

### **Belarus**

- Zyxel BY
- <https://www.zyxel.by>

### **Belgium**

- Zyxel Communications B.V.
- <https://www.zyxel.com/be/nl/>



- <https://www.zyxel.com/be/fr/>

## **Bulgaria**

- Zyxel България
- <https://www.zyxel.com/bg/bg/>

## **Czech Republic**

- Zyxel Communications Czech s.r.o
- <https://www.zyxel.com/cz/cs/>

## **Denmark**

- Zyxel Communications A/S
- <https://www.zyxel.com/dk/da/>

## **Estonia**

- Zyxel Estonia
- <https://www.zyxel.com/ee/et/>

## **Finland**

- Zyxel Communications
- <https://www.zyxel.com/fi/fi/>

## **France**

- Zyxel France
- <https://www.zyxel.fr>

## **Germany**

- Zyxel Deutschland GmbH
- <https://www.zyxel.com/de/de/>

## **Hungary**

- Zyxel Hungary & SEE
- <https://www.zyxel.com/hu/hu/>

## **Italy**

- Zyxel Communications Italy
- <https://www.zyxel.com/it/it/>

## **Latvia**

- Zyxel Latvia
- <https://www.zyxel.com/lv/lv/>

## **Lithuania**

- Zyxel Lithuania
- <https://www.zyxel.com/lt/lt/>

## **Netherlands**

- Zyxel Benelux
- <https://www.zyxel.com/nl/nl/>

## **Norway**

- Zyxel Communications
- <https://www.zyxel.com/no/no/>

## **Poland**

- Zyxel Communications Poland
- <https://www.zyxel.com/pl/pl/>

## **Romania**

- Zyxel Romania
- <https://www.zyxel.com/ro/ro>

## **Russia**

- Zyxel Russia
- <https://www.zyxel.com/ru/ru/>

## **Slovakia**

- Zyxel Communications Czech s.r.o. organizacna zlozka
- <https://www.zyxel.com/sk/sk/>

## **Spain**

- Zyxel Communications ES Ltd
- <https://www.zyxel.com/es/es/>

## **Sweden**

- Zyxel Communications
- <https://www.zyxel.com/se/sv/>

## **Switzerland**

- Studerus AG
- <https://www.zyxel.ch/de>
- <https://www.zyxel.ch/fr>

## **Turkey**

- Zyxel Turkey A.S.
- <https://www.zyxel.com/tr/tr/>

## **UK**

- Zyxel Communications UK Ltd.
- <https://www.zyxel.com/uk/en/>

## **Ukraine**

- Zyxel Ukraine
- <http://www.ua.zyxel.com>

## **South America**

### **Argentina**

- Zyxel Communications Corporation
- <https://www.zyxel.com/co/es/>

### **Brazil**

- Zyxel Communications Brasil Ltda.
- <https://www.zyxel.com/br/pt/>

### **Colombia**

- Zyxel Communications Corporation
- <https://www.zyxel.com/co/es/>

### **Ecuador**

- Zyxel Communications Corporation
- <https://www.zyxel.com/co/es/>

### **South America**

- Zyxel Communications Corporation
- <https://www.zyxel.com/co/es/>

## **Middle East**

### **Israel**

- Zyxel Communications Corporation
- <http://il.zyxel.com/>

## **Middle East**

- Zyxel Communications Corporation
- <https://www.zyxel.com/me/en/>

## **North America**

### **USA**

- Zyxel Communications, Inc. - North America Headquarters
- <https://www.zyxel.com/us/en/>

## **Oceania**

### **Australia**

- Zyxel Communications Corporation
- <https://www.zyxel.com/au/en/>

## **Africa**

### **South Africa**

- Nology (Pty) Ltd.
- <https://www.zyxel.com/za/en/>

# APPENDIX B

## IPv6

### Overview

IPv6 (Internet Protocol version 6), is designed to enhance IP address size and features. The increase in IPv6 address size to 128 bits (from the 32-bit IPv4 address) allows up to  $3.4 \times 10^{38}$  IP addresses.

### IPv6 Addressing

The 128-bit IPv6 address is written as eight 16-bit hexadecimal blocks separated by colons (:). This is an example IPv6 address `2001:0db8:1a2b:0015:0000:0000:1a2f:0000`.

IPv6 addresses can be abbreviated in two ways:

- Leading zeros in a block can be omitted. So `2001:0db8:1a2b:0015:0000:0000:1a2f:0000` can be written as `2001:db8:1a2b:15:0:0:1a2f:0`.
- Any number of consecutive blocks of zeros can be replaced by a double colon. A double colon can only appear once in an IPv6 address. So `2001:0db8:0000:0000:1a2f:0000:0000:0015` can be written as `2001:0db8::1a2f:0000:0000:0015`, `2001:0db8:0000:0000:1a2f::0015`, `2001:db8::1a2f:0:0:15` or `2001:db8:0:0:1a2f::15`.

### Prefix and Prefix Length

Similar to an IPv4 subnet mask, IPv6 uses an address prefix to represent the network address. An IPv6 prefix length specifies how many most significant bits (start from the left) in the address compose the network address. The prefix length is written as “/x” where x is a number. For example,

`2001:db8:1a2b:15::1a2f:0/32`

means that the first 32 bits (`2001:db8`) is the subnet prefix.

### Link-local Address

A link-local address uniquely identifies a device on the local network (the LAN). It is similar to a “private IP address” in IPv4. You can have the same link-local address on multiple interfaces on a device. A link-local unicast address has a predefined prefix of `fe80::/10`. The link-local unicast address format is as follows.

Table 45 Link-local Unicast Address Format

|              |         |              |
|--------------|---------|--------------|
| 1111 1110 10 | 0       | Interface ID |
| 10 bits      | 54 bits | 64 bits      |

### Global Address

A global address uniquely identifies a device on the Internet. It is similar to a “public IP address” in IPv4. A global unicast address starts with a 2 or 3.

## Unspecified Address

An unspecified address (0:0:0:0:0:0 or ::) is used as the source address when a device does not have its own address. It is similar to "0.0.0.0" in IPv4.

## Loopback Address

A loopback address (0:0:0:0:0:1 or ::1) allows a host to send packets to itself. It is similar to "127.0.0.1" in IPv4.

## Multicast Address

In IPv6, multicast addresses provide the same functionality as IPv4 broadcast addresses. Broadcasting is not supported in IPv6. A multicast address allows a host to send packets to all hosts in a multicast group.

Multicast scope allows you to determine the size of the multicast group. A multicast address has a predefined prefix of ff00::/8. The following table describes some of the predefined multicast addresses.

Table 46 Predefined Multicast Address

| MULTICAST ADDRESS  | DESCRIPTION                            |
|--------------------|--|
| FF01:0:0:0:0:0:1   | All hosts on a local node.             |
| FF01:0:0:0:0:0:2   | All routers on a local node.           |
| FF02:0:0:0:0:0:1   | All hosts on a local connected link.   |
| FF02:0:0:0:0:0:2   | All routers on a local connected link. |
| FF05:0:0:0:0:0:2   | All routers on a local site.           |
| FF05:0:0:0:0:0:1:3 | All DHCP servers on a local site.      |

The following table describes the multicast addresses which are reserved and can not be assigned to a multicast group.

Table 47 Reserved Multicast Address

| MULTICAST ADDRESS |
|-------------------|
| FF00:0:0:0:0:0:0  |
| FF01:0:0:0:0:0:0  |
| FF02:0:0:0:0:0:0  |
| FF03:0:0:0:0:0:0  |
| FF04:0:0:0:0:0:0  |
| FF05:0:0:0:0:0:0  |
| FF06:0:0:0:0:0:0  |
| FF07:0:0:0:0:0:0  |
| FF08:0:0:0:0:0:0  |
| FF09:0:0:0:0:0:0  |
| FF0A:0:0:0:0:0:0  |
| FF0B:0:0:0:0:0:0  |
| FF0C:0:0:0:0:0:0  |
| FF0D:0:0:0:0:0:0  |

Table 47 Reserved Multicast Address (continued)

| MULTICAST ADDRESS |
|-------------------|
| FF0E:0:0:0:0:0:0  |
| FF0F:0:0:0:0:0:0  |

## Subnet Masking

Both an IPv6 address and IPv6 subnet mask compose of 128-bit binary digits, which are divided into eight 16-bit blocks and written in hexadecimal notation. Hexadecimal uses four bits for each character (1 ~ 10, A ~ F). Each block's 16 bits are then represented by four hexadecimal characters. For example, FFFF:FFFF:FFFF:FFFF:FC00:0000:0000:0000.

## Interface ID

In IPv6, an interface ID is a 64-bit identifier. It identifies a physical interface (for example, an Ethernet port) or a virtual interface (for example, the management IP address for a VLAN). One interface should have a unique interface ID.

## EUI-64

The EUI-64 (Extended Unique Identifier) defined by the IEEE (Institute of Electrical and Electronics Engineers) is an interface ID format designed to adapt with IPv6. It is derived from the 48-bit (6-byte) Ethernet MAC address as shown next. EUI-64 inserts the hex digits ffe between the third and fourth bytes of the MAC address and complements the seventh bit of the first byte of the MAC address. See the following example.

|        |                                       |
|--------|---------------------------------------|
| MAC    | 00 : 13 : 49 : 12 : 34 : 56           |
| EUI-64 | 02 : 13 : 49 : FF : FE : 12 : 34 : 56 |

## Identity Association

An Identity Association (IA) is a collection of addresses assigned to a DHCP client, through which the server and client can manage a set of related IP addresses. Each IA must be associated with exactly one interface. The DHCP client uses the IA assigned to an interface to obtain configuration from a DHCP server for that interface. Each IA consists of a unique IAID and associated IP information.

The IA type is the type of address in the IA. Each IA holds one type of address. IA\_NA means an identity association for non-temporary addresses and IA\_TA is an identity association for temporary addresses. An IA\_NA option contains the T1 and T2 fields, but an IA\_TA option does not. The DHCPv6 server uses T1 and T2 to control the time at which the client contacts with the server to extend the lifetimes on any addresses in the IA\_NA before the lifetimes expire. After T1, the client sends the server (**S1**) (from which the addresses in the IA\_NA were obtained) a Renew message. If the time T2 is reached and the server does not respond, the client sends a Rebind message to any available server (**S2**). For an IA\_TA, the client may send a Renew or Rebind message at the client's discretion.

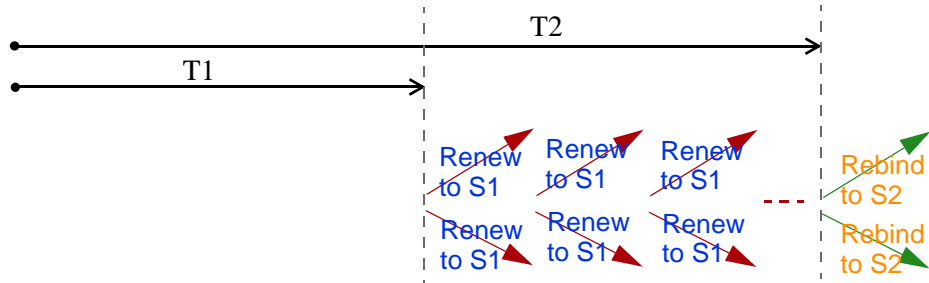

## DHCP Relay Agent

A DHCP relay agent is on the same network as the DHCP clients and helps forward messages between the DHCP server and clients. When a client cannot use its link-local address and a well-known multicast address to locate a DHCP server on its network, it then needs a DHCP relay agent to send a message to a DHCP server that is not attached to the same network.

The DHCP relay agent can add the remote identification (remote-ID) option and the interface-ID option to the Relay-Forward DHCPv6 messages. The remote-ID option carries a user-defined string, such as the system name. The interface-ID option provides slot number, port information and the VLAN ID to the DHCPv6 server. The remote-ID option (if any) is stripped from the Relay-Reply messages before the relay agent sends the packets to the clients. The DHCP server copies the interface-ID option from the Relay-Forward message into the Relay-Reply message and sends it to the relay agent. The interface-ID should not change even after the relay agent restarts.

## Prefix Delegation

Prefix delegation enables an IPv6 router to use the IPv6 prefix (network address) received from the ISP (or a connected uplink router) for its LAN. The WX Device uses the received IPv6 prefix (for example, 2001:db2::/48) to generate its LAN IP address. Through sending Router Advertisements (RAs) regularly by multicast, the WX Device passes the IPv6 prefix information to its LAN hosts. The hosts then can use the prefix to generate their IPv6 addresses.

## ICMPv6

Internet Control Message Protocol for IPv6 (ICMPv6 or ICMP for IPv6) is defined in RFC 4443. ICMPv6 has a preceding Next Header value of 58, which is different from the value used to identify ICMP for IPv4. ICMPv6 is an integral part of IPv6. IPv6 nodes use ICMPv6 to report errors encountered in packet processing and perform other diagnostic functions, such as "ping".

## Neighbor Discovery Protocol (NDP)

The Neighbor Discovery Protocol (NDP) is a protocol used to discover other IPv6 devices and track neighbor's reachability in a network. An IPv6 device uses the following ICMPv6 messages types:

- Neighbor solicitation: A request from a host to determine a neighbor's link-layer address (MAC address) and detect if the neighbor is still reachable. A neighbor being "reachable" means it responds to a neighbor solicitation message (from the host) with a neighbor advertisement message.
- Neighbor advertisement: A response from a node to announce its link-layer address.
- Router solicitation: A request from a host to locate a router that can act as the default router and forward packets.



- Router advertisement: A response to a router solicitation or a periodical multicast advertisement from a router to advertise its presence and other parameters.

## IPv6 Cache

An IPv6 host is required to have a neighbor cache, destination cache, prefix list and default router list. The WX Device maintains and updates its IPv6 caches constantly using the information from response messages. In IPv6, the WX Device configures a link-local address automatically, and then sends a neighbor solicitation message to check if the address is unique. If there is an address to be resolved or verified, the WX Device also sends out a neighbor solicitation message. When the WX Device receives a neighbor advertisement in response, it stores the neighbor's link-layer address in the neighbor cache. When the WX Device uses a router solicitation message to query for a router and receives a router advertisement message, it adds the router's information to the neighbor cache, prefix list and destination cache. The WX Device creates an entry in the default router list cache if the router can be used as a default router.

When the WX Device needs to send a packet, it first consults the destination cache to determine the next hop. If there is no matching entry in the destination cache, the WX Device uses the prefix list to determine whether the destination address is on-link and can be reached directly without passing through a router. If the address is un-link, the address is considered as the next hop. Otherwise, the WX Device determines the next-hop from the default router list or routing table. Once the next hop IP address is known, the WX Device looks into the neighbor cache to get the link-layer address and sends the packet when the neighbor is reachable. If the WX Device cannot find an entry in the neighbor cache or the state for the neighbor is not reachable, it starts the address resolution process. This helps reduce the number of IPv6 solicitation and advertisement messages.

## Multicast Listener Discovery

The Multicast Listener Discovery (MLD) protocol (defined in RFC 2710) is derived from IPv4's Internet Group Management Protocol version 2 (IGMPv2). MLD uses ICMPv6 message types, rather than IGMP message types. MLDv1 is equivalent to IGMPv2 and MLDv2 is equivalent to IGMPv3.

MLD allows an IPv6 switch or router to discover the presence of MLD listeners who wish to receive multicast packets and the IP addresses of multicast groups the hosts want to join on its network.

MLD snooping and MLD proxy are analogous to IGMP snooping and IGMP proxy in IPv4.

MLD filtering controls which multicast groups a port can join.

## MLD Messages

A multicast router or switch periodically sends general queries to MLD hosts to update the multicast forwarding table. When an MLD host wants to join a multicast group, it sends an MLD Report message for that address.

An MLD Done message is equivalent to an IGMP Leave message. When an MLD host wants to leave a multicast group, it can send a Done message to the router or switch. The router or switch then sends a group-specific query to the port on which the Done message is received to determine if other devices connected to this port should remain in the group.

## Example - Enabling IPv6 on Windows XP/2003/Vista

By default, Windows XP and Windows 2003 support IPv6. This example shows you how to use the `ipv6 install` command on Windows XP/2003 to enable IPv6. This also displays how to use the `ipconfig` command to see auto-generated IP addresses.

```
C:\>ipv6 install
Installing...
Succeeded.

C:\>ipconfig

Windows IP Configuration

Ethernet adapter Local Area Connection:

    Connection-specific DNS Suffix  . :
    IP Address. . . . . : 10.1.1.46
    Subnet Mask . . . . . : 255.255.255.0
    IP Address. . . . . : fe80::2d0:59ff:feb8:103c%4
    Default Gateway . . . . . : 10.1.1.254
```

IPv6 is installed and enabled by default in Windows Vista. Use the `ipconfig` command to check your automatic configured IPv6 address as well. You should see at least one IPv6 address available for the interface on your computer.

## Example - Enabling DHCPv6 on Windows XP

Windows XP does not support DHCPv6. If your network uses DHCPv6 for IP address assignment, you have to additionally install a DHCPv6 client software on your Windows XP. (Note: If you use static IP addresses or Router Advertisement for IPv6 address assignment in your network, ignore this section.)

This example uses Dibbler as the DHCPv6 client. To enable DHCPv6 client on your computer:

- 1 Install Dibbler and select the DHCPv6 client option on your computer.
- 2 After the installation is complete, select **Start > All Programs > Dibbler-DHCPv6 > Client Install as service**.
- 3 Select **Start > Control Panel > Administrative Tools > Services**.
- 4 Double click **Dibbler - a DHCPv6 client**.

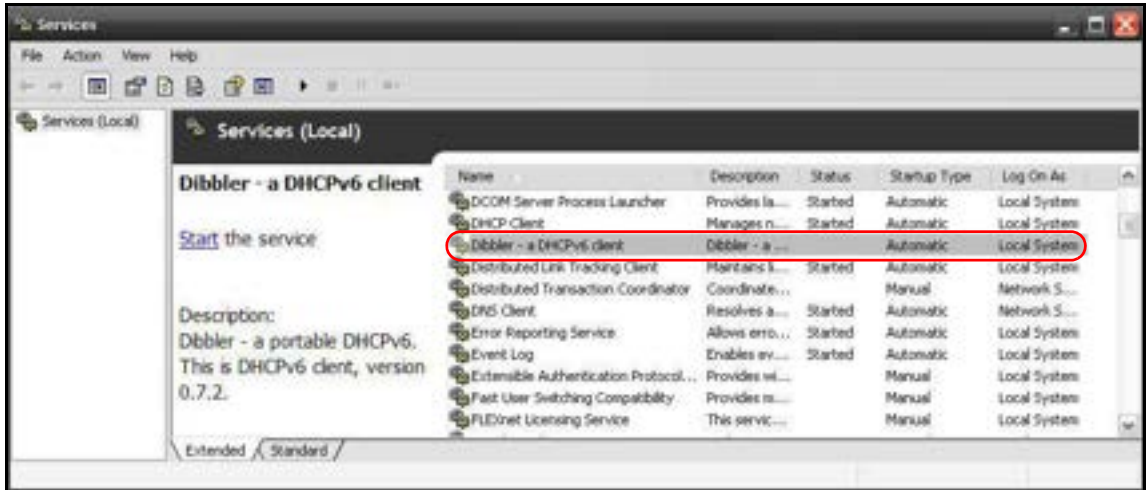

- 5 Click **Start** and then **OK**.

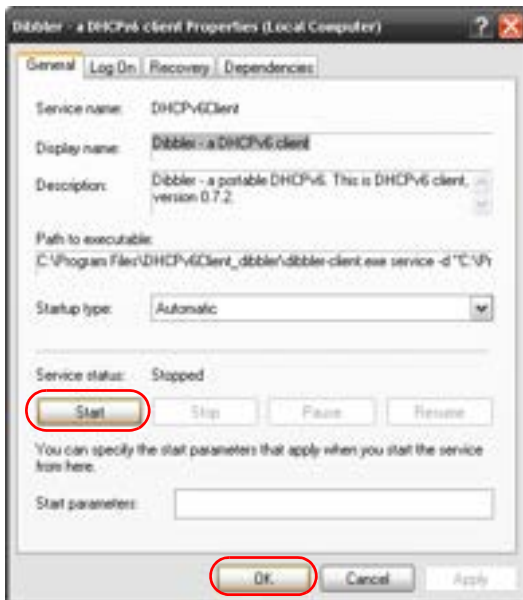

- 6 Now your computer can obtain an IPv6 address from a DHCPv6 server.

## Example - Enabling IPv6 on Windows 7

Windows 7 supports IPv6 by default. DHCPv6 is also enabled when you enable IPv6 on a Windows 7 computer.

To enable IPv6 in Windows 7:

- 1 Select **Control Panel > Network and Sharing Center > Local Area Connection**.
- 2 Select the **Internet Protocol Version 6 (TCP/IPv6)** checkbox to enable it.
- 3 Click **OK** to save the change.

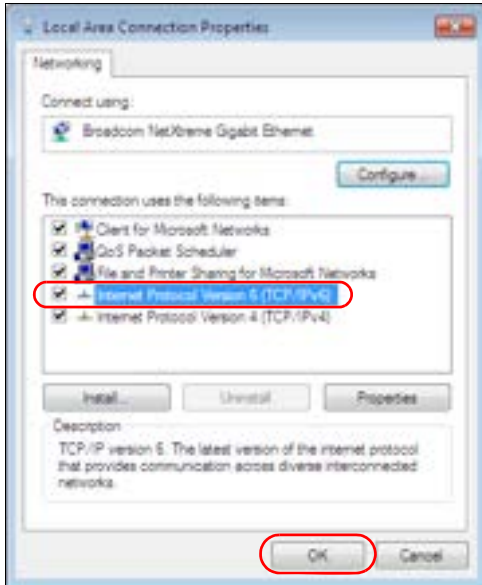

- 4 Click **Close** to exit the **Local Area Connection Status** screen.
- 5 Select **Start > All Programs > Accessories > Command Prompt**.
- 6 Use the `ipconfig` command to check your dynamic IPv6 address. This example shows a global address (2001:b021:2d::1000) obtained from a DHCP server.

```
C:\>ipconfig

Windows IP Configuration

Ethernet adapter Local Area Connection:

    Connection-specific DNS Suffix  . :
    IPv6 Address. . . . . : 2001:b021:2d::1000
    Link-local IPv6 Address . . . . . : fe80::25d8:dcab:c80a:5189%11
    IPv4 Address. . . . . : 172.16.100.61
    Subnet Mask . . . . . : 255.255.255.0
    Default Gateway . . . . . : fe80::213:49ff:feaa:7125%11
                                172.16.100.254
```

# APPENDIX C

## Services

The following table lists some commonly-used services and their associated protocols and port numbers.

- **Name:** This is a short, descriptive name for the service. You can use this one or create a different one, if you like.
- **Protocol:** This is the type of IP protocol used by the service. If this is **TCP/UDP**, then the service uses the same port number with TCP and UDP. If this is **USER-DEFINED**, the **Port(s)** is the IP protocol number, not the port number.
- **Port(s):** This value depends on the **Protocol**.
  - If the **Protocol** is **TCP**, **UDP**, or **TCP/UDP**, this is the IP port number.
  - If the **Protocol** is **USER**, this is the IP protocol number.
- **Description:** This is a brief explanation of the applications that use this service or the situations in which this service is used.

Table 48 Examples of Services

| NAME               | PROTOCOL                                 | PORT(S)                  | DESCRIPTION  |
|--------------------|--|--------------------------|--|
| AH (IPSEC_TUNNEL)  | User-Defined                             | 51                       | The IPSEC AH (Authentication Header) tunneling protocol uses this service.   |
| AIM                | TCP                                      | 5190                     | AOL's Internet Messenger service.  |
| AUTH               | TCP                                      | 113                      | Authentication protocol used by some servers.  |
| BGP                | TCP                                      | 179                      | Border Gateway Protocol.   |
| BOOTP_CLIENT       | UDP                                      | 68                       | DHCP Client.   |
| BOOTP_SERVER       | UDP                                      | 67                       | DHCP Server.   |
| CU-SEEME           | TCP/UDP<br>TCP/UDP                       | 7648<br>24032            | A popular videoconferencing solution from White Pines Software.  |
| DNS                | TCP/UDP                                  | 53                       | Domain Name Server, a service that matches web names (for instance <a href="http://www.zyxel.com">www.zyxel.com</a> ) to IP numbers. |
| ESP (IPSEC_TUNNEL) | User-Defined                             | 50                       | The IPSEC ESP (Encapsulation Security Protocol) tunneling protocol uses this service.  |
| FINGER             | TCP                                      | 79                       | Finger is a UNIX or Internet related command that can be used to find out if a user is logged on.                                    |
| FTP                | TCP<br>TCP                               | 20<br>21                 | File Transfer Protocol, a program to enable fast transfer of files, including large files that may not be possible by e-mail.        |
| H.323              | TCP                                      | 1720                     | NetMeeting uses this protocol.   |
| HTTP               | TCP                                      | 80                       | Hyper Text Transfer Protocol - a client/server protocol for the world wide web.  |
| HTTPS              | TCP                                      | 443                      | HTTPS is a secured http session often used in e-commerce.  |
| ICMP               | User-Defined                             | 1                        | Internet Control Message Protocol is often used for diagnostic purposes.   |
| ICQ                | UDP                                      | 4000                     | This is a popular Internet chat program.   |
| IGMP (MULTICAST)   | User-Defined                             | 2                        | Internet Group Multicast Protocol is used when sending packets to a specific group of hosts.   |
| IKE                | UDP                                      | 500                      | The Internet Key Exchange algorithm is used for key distribution and management.   |
| IMAP4              | TCP                                      | 143                      | The Internet Message Access Protocol is used for e-mail.   |
| IMAP4S             | TCP                                      | 993                      | This is a more secure version of IMAP4 that runs over SSL.   |
| IRC                | TCP/UDP                                  | 6667                     | This is another popular Internet chat program.   |
| MSN Messenger      | TCP                                      | 1863                     | Microsoft Networks' messenger service uses this protocol.  |
| NetBIOS            | TCP/UDP<br>TCP/UDP<br>TCP/UDP<br>TCP/UDP | 137<br>138<br>139<br>445 | The Network Basic Input/Output System is used for communication between computers in a LAN.  |
| NEW-ICQ            | TCP                                      | 5190                     | An Internet chat program.  |
| NEWS               | TCP                                      | 144                      | A protocol for news groups.  |

Table 48 Examples of Services (continued)

| NAME              | PROTOCOL     | PORT(S) | DESCRIPTION   |
|-------------------|--------------|---------|---|
| NFS               | UDP          | 2049    | Network File System - NFS is a client/server distributed file service that provides transparent file sharing for network environments.  |
| NNTP              | TCP          | 119     | Network News Transport Protocol is the delivery mechanism for the USENET newsgroup service.   |
| PING              | User-Defined | 1       | Packet Internet Groper is a protocol that sends out ICMP echo requests to test whether or not a remote host is reachable.   |
| POP3              | TCP          | 110     | Post Office Protocol version 3 lets a client computer get e-mail from a POP3 server through a temporary connection (TCP/IP or other).   |
| POP3S             | TCP          | 995     | This is a more secure version of POP3 that runs over SSL.   |
| PPTP              | TCP          | 1723    | Point-to-Point Tunneling Protocol enables secure transfer of data over public networks. This is the control channel.  |
| PPTP_TUNNEL (GRE) | User-Defined | 47      | PPTP (Point-to-Point Tunneling Protocol) enables secure transfer of data over public networks. This is the data channel.  |
| RCMD              | TCP          | 512     | Remote Command Service.   |
| REAL_AUDIO        | TCP          | 7070    | A streaming audio service that enables real time sound over the web.  |
| REXEC             | TCP          | 514     | Remote Execution Daemon.  |
| RLOGIN            | TCP          | 513     | Remote Login.   |
| ROADRUNNER        | TCP/UDP      | 1026    | This is an ISP that provides services mainly for cable modems.  |
| RTELNET           | TCP          | 107     | Remote Telnet.  |
| RTSP              | TCP/UDP      | 554     | The Real Time Streaming (media control) Protocol (RTSP) is a remote control for multimedia on the Internet.   |
| SFTP              | TCP          | 115     | The Simple File Transfer Protocol is an old way of transferring files between computers.  |
| SMTP              | TCP          | 25      | Simple Mail Transfer Protocol is the message-exchange standard for the Internet. SMTP enables you to move messages from one e-mail server to another.                           |
| SMTPS             | TCP          | 465     | This is a more secure version of SMTP that runs over SSL.   |
| SNMP              | TCP/UDP      | 161     | Simple Network Management Program.  |
| SNMP-TRAPS        | TCP/UDP      | 162     | Traps for use with the SNMP (RFC:1215).   |
| SQL-NET           | TCP          | 1521    | Structured Query Language is an interface to access data on many different types of database systems, including mainframes, midrange systems, UNIX systems and network servers. |
| SSDP              | UDP          | 1900    | The Simple Service Discovery Protocol supports Universal Plug-and-Play (UPnP).  |
| SSH               | TCP/UDP      | 22      | Secure Shell Remote Login Program.  |
| STRM WORKS        | UDP          | 1558    | Stream Works Protocol.  |
| SYSLOG            | UDP          | 514     | Syslog allows you to send system logs to a UNIX server.   |

Table 48 Examples of Services (continued)

| <b>NAME</b> | <b>PROTOCOL</b> | <b>PORT(S)</b>           | <b>DESCRIPTION</b>   |
|-------------|-----------------|--------------------------|--|
| TACACS      | UDP             | 49                       | Login Host Protocol used for (Terminal Access Controller Access Control System).   |
| TELNET      | TCP             | 23                       | Telnet is the login and terminal emulation protocol common on the Internet and in UNIX environments. It operates over TCP/IP networks. Its primary function is to allow users to log into remote host systems. |
| VDOLIVE     | TCP<br>UDP      | 7000<br>user-<br>defined | A videoconferencing solution. The UDP port number is specified in the application.   |



# APPENDIX D

## Legal Information

### Copyright

Copyright © 2020 by Zyxel Communications Corporation.

The contents of this publication may not be reproduced in any part or as a whole, transcribed, stored in a retrieval system, translated into any language, or transmitted in any form or by any means, electronic, mechanical, magnetic, optical, chemical, photocopying, manual, or otherwise, without the prior written permission of Zyxel Communications Corporation.

Published by Zyxel Communications Corporation. All rights reserved.

### Disclaimer

Zyxel does not assume any liability arising out of the application or use of any products, or software described herein. Neither does it convey any license under its patent rights nor the patent rights of others. Zyxel further reserves the right to make changes in any products described herein without notice. This publication is subject to change without notice.

### Regulatory Notice and Statement

#### UNITED STATES of AMERICA



The following information applies if you use the product within USA area.

US Importer: Zyxel Communications, Inc, 1130 North Miller Street Anaheim, CA92806-2001, <https://www.zyxel.com/us/en/>

#### FCC EMC Statement

- The device complies with Part 15 of FCC rules. Operation is subject to the following two conditions:
  - (1) This device may not cause harmful interference, and
  - (2) This device must accept any interference received, including interference that may cause undesired operation.
- Changes or modifications not expressly approved by the party responsible for compliance could void the user's authority to operate the device.
- This product has been tested and complies with the specifications for a Class B digital device, pursuant to Part 15 of the FCC Rules. These limits are designed to provide reasonable protection against harmful interference in a residential installation. This device generates, uses, and can radiate radio frequency energy and, if not installed and used according to the instructions, may cause harmful interference to radio communications. However, there is no guarantee that interference will not occur in a particular installation.
- If this device does cause harmful interference to radio or television reception, which is found by turning the device off and on, the user is encouraged to try to correct the interference by one or more of the following measures:
  - Reorient or relocate the receiving antenna
  - Increase the separation between the devices
  - Connect the equipment to an outlet other than the receiver's
  - Consult a dealer or an experienced radio/TV technician for assistance

The following information applies if you use the product with RF function within USA area.

#### FCC Radiation Exposure Statement

- This device complies with FCC RF radiation exposure limits set forth for an uncontrolled environment.
- This transmitter must be at least 20 cm from the user and must not be co-located or operating in conjunction with any other antenna or transmitter.
- Operation of this device is restricted to indoor use only, except for relevant user's manual mention that this device can be installed into the external environment.

#### CANADA

The following information applies if you use the product within Canada area.

#### Innovation, Science and Economic Development Canada ICES Statement

CAN ICES-3 (B)/NMB-3(B)

### Innovation, Science and Economic Development Canada RSS-GEN & RSS-247 Statement

- This device contains licence-exempt transmitter(s)/receiver(s) that comply with Innovation, Science and Economic Development Canada's licence-exempt RSS(s). Operation is subject to the following two conditions: (1) this device may not cause interference, and (2) this device must accept any interference, including interference that may cause undesired operation of the device.
- This radio transmitter has been approved by Innovation, Science and Economic Development Canada to operate with the antenna types listed below with the maximum permissible gain indicated. Antenna types not included in this list that have a gain greater than the maximum gain indicated for any type listed, are strictly prohibited for use with this device.

If the product with 5G wireless function operating in 5150-5250 MHz and 5725-5850 MHz, the following attention must be paid,

- The device for operation in the band 5150-5250 MHz is only for indoor use to reduce the potential for harmful interference to co-channel mobile satellite systems.
- For devices with detachable antenna(s), the maximum antenna gain permitted for devices in the band 5725-5850 MHz shall be such that the equipment still complies with the e.i.r.p. limits as appropriate; and
- Where applicable, antenna type(s), antenna model(s), and the worst-case tilt angle(s) necessary to remain compliant with the e.i.r.p. elevation mask requirement set forth in Section 6.2.2.3 of RSS 247 shall be clearly indicated.

If the product with 5G wireless function operating in 5250-5350 MHz and 5470-5725 MHz, the following attention must be paid.

- For devices with detachable antenna(s), the maximum antenna gain permitted for devices in the bands 5250-5350 MHz and 5470-5725 MHz shall be such that the equipment still complies with the e.i.r.p. limit.
- L'émetteur/récepteur exempt de licence contenu dans le présent appareil est conforme aux CNR d'Innovation, Sciences et Développement économique Canada applicables aux appareils radio exempts de licence. L'exploitation est autorisée aux deux conditions suivantes : (1) l'appareil ne doit pas produire de brouillage; (2) l'appareil doit accepter tout brouillage radioélectrique subi, même si le brouillage est susceptible d'en compromettre le fonctionnement.
- Le présent émetteur radio a été approuvé par Innovation, Sciences et Développement économique Canada pour fonctionner avec les types d'antenne énumérés ci-dessous et ayant un gain admissible maximal. Les types d'antenne non inclus dans cette liste, et dont le gain est supérieur au gain maximal indiqué pour tout type figurant sur la liste, sont strictement interdits pour l'exploitation de l'émetteur.

Lorsque la fonction sans fil 5G fonctionnant en 5150-5250 MHz and 5725-5850 MHz est activée pour ce produit, il est nécessaire de porter une attention particulière aux choses suivantes

- Les dispositifs fonctionnant dans la bande de 5 150 à 5 250 MHz sont réservés uniquement pour une utilisation à l'intérieur afin de réduire les risques de brouillage préjudiciable aux systèmes de satellites mobiles utilisant les mêmes canaux;
- Pour les dispositifs munis d'antennes amovibles, le gain maximal d'antenne permis (pour les dispositifs utilisant la bande de 5 725 à 5 850 MHz) doit être conforme à la limite de la p.i.r.e. spécifiée, selon le cas;
- Lorsqu'il y a lieu, les types d'antennes (s'il y en a plusieurs), les numéros de modèle de l'antenne et les pires angles d'inclinaison nécessaires pour rester conforme à l'exigence de la p.i.r.e. applicable au masque d'élevation, énoncée à la section 6.2.2.3 du CNR-247, doivent être clairement indiqués.

Lorsque la fonction sans fil 5G fonctionnant en 5250-5350 MHz et 5470-5725 MHz est activée pour ce produit, il est nécessaire de porter une attention particulière aux choses suivantes.

- Pour les dispositifs munis d'antennes amovibles, le gain maximal d'antenne permis pour les dispositifs utilisant les bandes de 5 250 à 5 350 MHz et de 5 470 à 5 725 MHz doit être conforme à la limite de la p.i.r.e.

### Industry Canada radiation exposure statement

This device complies with ISED radiation exposure limits set forth for an uncontrolled environment. This device should be installed and operated with a minimum distance of 20 cm between the radiator and your body.

### Déclaration d'exposition aux radiations:

Cet équipement est conforme aux limites d'exposition aux rayonnements ISED établies pour un environnement non contrôlé. Cet équipement doit être installé et utilisé avec un minimum de 20 cm de distance entre la source de rayonnement et votre corps.

## EUROPEAN UNION



The following information applies if you use the product within the European Union.

### Declaration of Conformity with Regard to EU Directive 2014/53/EU (Radio Equipment Directive, RED)

- Compliance information for wireless products relevant to the EU and other Countries following the EU Directive 2014/53/EU (RED). And this product may be used in all EU countries (and other countries following the EU Directive 2014/53/EU) without any limitation except for the countries mentioned below table:
- In the majority of the EU and other European countries, the 5GHz bands have been made available for the use of wireless local area networks (LANs). Later in this document you will find an overview of countries in which additional restrictions or requirements or both are applicable. The requirements for any country may evolve. Zyxel recommends that you check with the local authorities for the latest status of their national regulations for the 5GHz wireless LANs.
- If this device for operation in the band 5150-5350 MHz, it is for indoor use only.
- This equipment should be installed and operated with a minimum distance of 20 cm between the radio equipment and your body.
- The maximum RF power operating for each band as follows:

The band 2,400 to 2,483.5 MHz is 93.54 mW

The band 5,150 to 5,350 MHz is 189.23 mW

The band 5,470 to 5,725 MHz is 931.11 mW

|                                |  |
|--------------------------------|--|
| Български<br>(Bulgarian)       | <p>С настоящото Zyxel декларира, че това оборудване е в съответствие със съществените изисквания и другите приложими разпоредбите на Директива 2014/53/ЕС.</p> <p><b>National Restrictions</b></p> <ul style="list-style-type: none"> <li>• The Belgian Institute for Postal Services and Telecommunications (BIPT) must be notified of any outdoor wireless link having a range exceeding 300 meters. Please check <a href="http://www.bipt.be">http://www.bipt.be</a> for more details.</li> <li>• Draadloze verbindingen voor buitengebruik en met een reikwijdte van meer dan 300 meter dienen aangemeld te worden bij het Belgisch Instituut voor postdiensten en telecommunicatie (BIPT). Zie <a href="http://www.bipt.be">http://www.bipt.be</a> voor meer gegevens.</li> <li>• Les liaisons sans fil pour une utilisation en extérieur d'une distance supérieure à 300 mètres doivent être notifiées à l'Institut Belge des services Postaux et des Télécommunications (IBPT). Visitez <a href="http://www.ibpt.be">http://www.ibpt.be</a> pour de plus amples détails.</li> </ul>           |
| Español<br>(Spanish)           | Por medio de la presente Zyxel declara que el equipo cumple con los requisitos esenciales y cualesquiera otras disposiciones aplicables o exigibles de la Directiva 2014/53/UE..   |
| Čeština<br>(Czech)             | Zyxel tímto prohlašuje, že tento zařízení je ve shodě se základními požadavky a dalšími příslušnými ustanoveními směrnice 2014/53/EU.  |
| Dansk (Danish)                 | <p>Undertegnede Zyxel erklærer herved, at følgende udstyr overholder de væsentlige krav og øvrige relevante krav i direktiv 2014/53/EU.</p> <p><b>National Restrictions</b></p> <ul style="list-style-type: none"> <li>• In Denmark, the band 5150 - 5350 MHz is also allowed for outdoor usage.</li> <li>• I Danmark må frekvensbåndet 5150 - 5350 også anvendes udendørs.</li> </ul>   |
| Deutsch<br>(German)            | Hiermit erklärt Zyxel, dass sich das Gerät Ausstattung in Übereinstimmung mit den grundlegenden Anforderungen und den übrigen einschlägigen Bestimmungen der Richtlinie 2014/53/EU befindet.   |
| Eesti keel<br>(Estonian)       | Käesolevaga kinnitab Zyxel seadme seadme vastavust direktiivi 2014/53/EL põhinõuetele ja nimetatud direktiivist tulenevatele teistele asjakohastele sätetele.  |
| Ελληνικά<br>(Greek)            | ΜΕ ΤΗΝ ΠΑΡΟΥΣΑ Zyxel ΔΗΛΩΝΕΙ ΟΤΙ ΕΞΟΠΛΙΣΜΟΣ ΣΥΜΜΟΡΦΩΝΕΤΑΙ ΠΡΟΣ ΤΙΣ ΟΥΣΙΩΔΕΙΣ ΑΠΑΙΤΗΣΕΙΣ ΚΑΙ ΤΙΣ ΛΟΙΠΕΣ ΣΧΕΤΙΚΕΣ ΔΙΑΤΑΞΕΙΣ ΤΗΣ ΟΔΗΓΙΑΣ 2014/53/ΕΕ.  |
| English                        | Hereby, Zyxel declares that this device is in compliance with the essential requirements and other relevant provisions of Directive 2014/53/EU.  |
| Français<br>(French)           | Par la présente Zyxel déclare que l'appareil équipements est conforme aux exigences essentielles et aux autres dispositions pertinentes de la directive 2014/53/UE.  |
| Hrvatski<br>(Croatian)         | Zyxel ovime izjavljuje da je radijska oprema tipa u skladu s Direktivom 2014/53/UE.  |
| Íslenska<br>(Icelandic)        | Hér með lýsir, Zyxel því yfir að þessi búnaður er í samræmi við grunnkröfur og önnur viðeigandi ákvæði tilskipunar 2014/53/UE.   |
| Italiano (Italian)             | <p>Con la presente Zyxel dichiara che questo attrezzatura è conforme ai requisiti essenziali ed alle altre disposizioni pertinenti stabilite dalla direttiva 2014/53/UE.</p> <p><b>National Restrictions</b></p> <ul style="list-style-type: none"> <li>• This product meets the National Radio Interface and the requirements specified in the National Frequency Allocation Table for Italy. Unless this wireless LAN product is operating within the boundaries of the owner's property, its use requires a "general authorization." Please check <a href="http://www.sviluppoeconomico.gov.it/">http://www.sviluppoeconomico.gov.it/</a> for more details.</li> <li>• Questo prodotto è conforme alla specifiche di Interfaccia Radio Nazionali e rispetta il Piano Nazionale di ripartizione delle frequenze in Italia. Se non viene installato all'interno del proprio fondo, l'utilizzo di prodotti Wireless LAN richiede una "Autorizzazione Generale". Consultare <a href="http://www.sviluppoeconomico.gov.it/">http://www.sviluppoeconomico.gov.it/</a> per maggiori dettagli.</li> </ul> |
| Latviešu valoda<br>(Latvian)   | <p>Ar šo Zyxel deklarē, ka iekārtas atbilst Direktīvas 2014/53/ES būtiskajām prasībām un citiem ar to saistītajiem noteikumiem.</p> <p><b>National Restrictions</b></p> <ul style="list-style-type: none"> <li>• The outdoor usage of the 2.4 GHz band requires an authorization from the Electronic Communications Office. Please check <a href="http://www.esd.lv">http://www.esd.lv</a> for more details.</li> <li>• 2.4 GHz frekvenču joslas izmantošanai ārpus telpām nepieciešama atļauja no Elektronisko sakaru direkcijas. Vairāk informācijas: <a href="http://www.esd.lv">http://www.esd.lv</a>.</li> </ul>  |
| Lietuvių kalba<br>(Lithuanian) | Šiuo Zyxel deklaruoja, kad šis įranga atitinka esminius reikalavimus ir kitas 2014/53/ES Direktyvos nuostatas.   |
| Magyar<br>(Hungarian)          | Alulírott, Zyxel nyilatkozom, hogy a berendezés megfelel a vonatkozó alapvető követelményeknek és az 2014/53/EU irányelv egyéb előírásainak.   |
| Malti (Maltese)                | Hawnhekk, Zyxel, jiddikjara li dan tagħmir jikkonforma mal-htigijiet essenzjali u ma provvedimenti oħrajn rilevanti li hemm fid-Direttiva 2014/53/UE.  |
| Nederlands<br>(Dutch)          | Hierbij verklaart Zyxel dat het toestel uitrusting in overeenstemming is met de essentiële eisen en de andere relevante bepalingen van richtlijn 2014/53/EU.   |
| Polski (Polish)                | Niniejszym Zyxel oświadcza, że sprzęt jest zgodny z zasadniczymi wymogami oraz pozostałymi stosownymi postanowieniami Dyrektywy 2014/53/UE.  |
| Português<br>(Portuguese)      | Zyxel declara que este equipamento está conforme com os requisitos essenciais e outras disposições da Directiva 2014/53/UE.  |

|                       |   |
|-----------------------|---|
| Română (Romanian)     | Prin prezenta, Zyxel declară că acest echipament este în conformitate cu cerințele esențiale și alte prevederi relevante ale Directivei 2014/53/UE.                     |
| Slovenčina (Slovak)   | Zyxel týmto vyhlasuje, že zariadenia spĺňa základné požiadavky a všetky príslušné ustanovenia Smernice 2014/53/EÚ.  |
| Slovenščina (Slovene) | Zyxel izjavlja, da je ta oprema v skladu z bistvenimi zahtevami in ostalimi relevantnimi določili direktive 2014/53/EU.   |
| Suomi (Finnish)       | Zyxel vakuuttaa täten että laitteen tyyppinen laite on direktiivin 2014/53/EU oleellisten vaatimusten ja sitä koskevien direktiivin muiden ehtojen mukainen.            |
| Svenska (Swedish)     | Härmed intygar Zyxel att denna utrustning står i överensstämmelse med de väsentliga egenskapskrav och övriga relevanta bestämmelser som framgår av direktiv 2014/53/EU. |
| Norsk (Norwegian)     | Erklærer herved Zyxel at dette utstyret er i samsvar med de grunnleggende kravene og andre relevante bestemmelser i direktiv 2014/53/EU.                                |

**Notes:**

- Although Norway, Switzerland and Liechtenstein are not EU member states, the EU Directive 2014/53/EU has also been implemented in those countries.
- The regulatory limits for maximum output power are specified in EIRP. The EIRP level (in dBm) of a device can be calculated by adding the gain of the antenna used (specified in dBi) to the output power available at the connector (specified in dBm).

**List of national codes**

| COUNTRY        | ISO 3166 2 LETTER CODE | COUNTRY        | ISO 3166 2 LETTER CODE |
|----------------|------------------------|----------------|------------------------|
| Austria        | AT                     | Liechtenstein  | LI                     |
| Belgium        | BE                     | Lithuania      | LT                     |
| Bulgaria       | BG                     | Luxembourg     | LU                     |
| Croatia        | HR                     | Malta          | MT                     |
| Cyprus         | CY                     | Netherlands    | NL                     |
| Czech Republic | CZ                     | Norway         | NO                     |
| Denmark        | DK                     | Poland         | PL                     |
| Estonia        | EE                     | Portugal       | PT                     |
| Finland        | FI                     | Romania        | RO                     |
| France         | FR                     | Serbia         | RS                     |
| Germany        | DE                     | Slovakia       | SK                     |
| Greece         | GR                     | Slovenia       | SI                     |
| Hungary        | HU                     | Spain          | ES                     |
| Iceland        | IS                     | Switzerland    | CH                     |
| Ireland        | IE                     | Sweden         | SE                     |
| Italy          | IT                     | Turkey         | TR                     |
| Latvia         | LV                     | United Kingdom | GB                     |

**Safety Warnings**

- Do not use this product near water, for example, in a wet basement or near a swimming pool.
- Do not expose your device to dampness, dust or corrosive liquids.
- Do not store things on the device.
- Do not obstruct the device ventilation slots as insufficient airflow may harm your device. For example, do not place the device in an enclosed space such as a box or on a very soft surface such as a bed or sofa.
- Do not install, use, or service this device during a thunderstorm. There is a remote risk of electric shock from lightning.
- Connect ONLY suitable accessories to the device.
- Do not open the device or unit. Opening or removing covers can expose you to dangerous high voltage points or other risks.
- Only qualified service personnel should service or disassemble this device. Please contact your vendor for further information.
- Make sure to connect the cables to the correct ports.
- Place connecting cables carefully so that no one will step on them or stumble over them.
- Always disconnect all cables from this device before servicing or disassembling.
- Do not remove the plug and connect it to a power outlet by itself; always attach the plug to the power adaptor first before connecting it to a power outlet.
- Do not allow anything to rest on the power adaptor or cord and do NOT place the product where anyone can walk on the power adaptor or cord.
- Please use the provided or designated connection cables/power cables/adaptors. Connect it to the right supply voltage (for example, 110V AC in North America or 230V AC in Europe). If the power adaptor or cord is damaged, it might cause electrocution. Remove it from the device and the power source, repairing the power adapter or cord is prohibited. Contact your local vendor to order a new one.
- Do not use the device outside, and make sure all the connections are indoors. There is a remote risk of electric shock from lightning.

- CAUTION: Risk of explosion if battery is replaced by an incorrect type, dispose of used batteries according to the instruction. Dispose them at the applicable collection point for the recycling of electrical and electronic devices. For detailed information about recycling of this product, please contact your local city office, your household waste disposal service or the store where you purchased the product.
- The following warning statements apply, where the disconnect device is not incorporated in the device or where the plug on the power supply cord is intended to serve as the disconnect device,
  - For permanently connected devices, a readily accessible disconnect device shall be incorporated external to the device;
  - For pluggable devices, the socket-outlet shall be installed near the device and shall be easily accessible.

## Important Safety Instructions

- Caution! The RJ-45 jacks are not used for telephone line connection.
- Caution! Do not use this product near water, for example a wet basement or near a swimming pool.
- Caution! Avoid using this product (other than a cordless type) during an electrical storm. There may be a remote risk of electric shock from lightning.
- Caution! Always disconnect all telephone lines from the wall outlet before servicing or disassembling this product.
- Attention: Les prises RJ-45 ne sont pas utilisés pour la connexion de la ligne téléphonique.
- Attention: Ne pas utiliser ce produit près de l'eau, par exemple un sous-sol humide ou près d'une piscine.
- Attention: Évitez d'utiliser ce produit (autre qu'un type sans fil) pendant un orage. Il peut y avoir un risque de choc électrique de la foudre.
- Attention: Toujours débrancher toutes les lignes téléphoniques de la prise murale avant de réparer ou de démonter ce produit.

## Environment Statement

### ErP (Energy-related Products)

Zyxel products put on the EU market in compliance with the requirement of the European Parliament and the Council published Directive 2009/125/EC establishing a framework for the setting of ecodesign requirements for energy-related products (recast), so called as "ErP Directive (Energy-related Products directive)" as well as ecodesign requirement laid down in applicable implementing measures, power consumption has satisfied regulation requirements which are:

- Network standby power consumption < 8W, and/or
- Off mode power consumption < 0.5W, and/or
- Standby mode power consumption < 0.5W.

(Wireless setting, please refer to the chapter about wireless settings for more detail.)

### European Union - Disposal and Recycling Information

The symbol below means that according to local regulations your product and/or its battery shall be disposed of separately from domestic waste. If this product is end of life, take it to a recycling station designated by local authorities. At the time of disposal, the separate collection of your product and/or its battery will help save natural resources and ensure that the environment is sustainable development.

Die folgende Symbol bedeutet, dass Ihr Produkt und/oder seine Batterie gemäß den örtlichen Bestimmungen getrennt vom Hausmüll entsorgt werden muss. Wenden Sie sich an eine Recyclingstation, wenn dieses Produkt das Ende seiner Lebensdauer erreicht hat. Zum Zeitpunkt der Entsorgung wird die getrennte Sammlung von Produkt und/oder seiner Batterie dazu beitragen, natürliche Ressourcen zu sparen und die Umwelt und die menschliche Gesundheit zu schützen.

El símbolo de abajo indica que según las regulaciones locales, su producto y/o su batería deberán depositarse como basura separada de la doméstica. Cuando este producto alcance el final de su vida útil, llévelo a un punto limpio. Cuando llegue el momento de desechar el producto, la recogida por separado éste y/o su batería ayudará a salvar los recursos naturales y a proteger la salud humana y medioambiental.

Le symbole ci-dessous signifie que selon les réglementations locales votre produit et/ou sa batterie doivent être éliminés séparément des ordures ménagères. Lorsque ce produit atteint sa fin de vie, amenez-le à un centre de recyclage. Au moment de la mise au rebut, la collecte séparée de votre produit et/ou de sa batterie aidera à économiser les ressources naturelles et protéger l'environnement et la santé humaine.

Il simbolo sotto significa che secondo i regolamenti locali il vostro prodotto e/o batteria deve essere smaltito separatamente dai rifiuti domestici. Quando questo prodotto raggiunge la fine della vita di servizio portarlo a una stazione di riciclaggio. Al momento dello smaltimento, la raccolta separata del vostro prodotto e/o della sua batteria aiuta a risparmiare risorse naturali e a proteggere l'ambiente e la salute umana.

Symbolen innebär att enligt lokal lagstiftning ska produkten och/eller dess batteri kastas separat från hushållsavfallet. När den här produkten når slutet av sin livslängd ska du ta den till en återvinningsstation. Vid tiden för kasseringen bidrar du till en bättre miljö och mänsklig hälsa genom att göra dig av med den på ett återvinningsställe.



## 台灣



以下訊息僅適用於產品具有無線功能且銷售至台灣地區

- 第十二條 經型式認證合格之低功率射頻電機，非經許可，公司，商號或使用者均不得擅自變更頻率、加大功率或變更原設計之特性及功能。
- 第十四條 低功率射頻電機之使用不得影響飛航安全及干擾合法通信；經發現有干擾現象時，應立即停用，並改善至無干擾時方得繼續使用。前項合法通信，指依電信法規定作業之無線電通信。低功率射頻電機須忍受合法通信或工業、科學及醫療用電波輻射性電機設備之干擾。
- 無線資訊傳輸設備忍受合法通信之干擾且不得干擾合法通信；如造成干擾，應立即停用，俟無干擾之虞，始得繼續使用。
- 無線資訊傳輸設備的製造廠商應確保頻率穩定性，如依製造廠商使用手冊上所述正常操作，發射的信號應維持於操作頻帶中
- 使用無線產品時，應避免影響附近雷達系統之操作。
- 高增益指向性天線只得應用於固定式點對點系統。

以下訊息僅適用於產品屬於專業安裝並銷售至台灣地區

- 本器材須經專業工程人員安裝及設定，始得設置使用，且不得直接販售給一般消費者。





安全警告 - 為了您的安全，請先閱讀以下警告及指示：

- 請勿將此產品接近水、火焰或放置在高溫的環境。
- 避免設備接觸：
  - 任何液體 - 切勿讓設備接觸水、雨水、高濕度、污水腐蝕性的液體或其他水份。
  - 灰塵及污物 - 切勿接觸灰塵、污物、沙土、食物或其他不適合的材料。
- 雷雨天氣時，不要安裝，使用或維修此設備。有遭受電擊的風險。
- 切勿重摔或撞擊設備，並勿使用不正確的電源變壓器。
- 若接上不正確的電源變壓器會有爆炸的風險。
- 請勿隨意更換產品內的電池。
- 如果更換不正確之電池型式，會有爆炸的風險，請依製造商說明書處理使用過之電池。
- 請將廢電池丟棄在適當的電器或電子設備回收處。
- 請勿將設備解體。
- 請勿阻礙設備的散熱孔，空氣對流不足將會造成設備損害。
- 請插在正確的電壓供給插座（如：北美 / 台灣電壓 110V AC，歐洲是 230V AC）。
- 假若電源變壓器或電源變壓器的纜線損壞，請從插座拔除，若您還繼續插電使用，會有觸電死亡的風險。
- 請勿試圖修理電源變壓器或電源變壓器的纜線，若有毀損，請直接聯絡您購買的店家，購買一個新的電源變壓器。
- 請勿將此設備安裝於室外，此設備僅適合放置於室內。
- 請勿隨一般垃圾丟棄。
- 請參閱產品背貼上的設備額定功率。
- 請參考產品型錄或是彩盒上的作業溫度。
- 產品沒有斷電裝置或者採用電源線的插頭視為斷電裝置的一部分，以下警語將適用：
  - 對永久連接之設備，在設備外部須安裝可觸及之斷電裝置；
  - 對插接式之設備，插座必須接近安裝之地點而且是易於觸及的。

## About the Symbols

Various symbols are used in this product to ensure correct usage, to prevent danger to the user and others, and to prevent property damage. The meaning of these symbols are described below. It is important that you read these descriptions thoroughly and fully understand the contents.

### Explanation of the Symbols

| SYMBOL  | EXPLANATION  |
|---|--|
|  | Alternating current (AC):<br>AC is an electric current in which the flow of electric charge periodically reverses direction.                                   |
|  | Direct current (DC):<br>DC is the unidirectional flow or movement of electric charge carriers.   |
|  | Earth; ground:<br>A wiring terminal intended for connection of a Protective Earthing Conductor.  |
|  | Class II equipment:<br>The method of protection against electric shock in the case of class II equipment is either double insulation or reinforced insulation. |

### Viewing Certifications

Go to <http://www.zyxel.com> to view this product's documentation and certifications.

### Zyxel Limited Warranty

Zyxel warrants to the original end user (purchaser) that this product is free from any defects in material or workmanship for a specific period (the Warranty Period) from the date of purchase. The Warranty Period varies by region. Check with your vendor and/or the authorized Zyxel local distributor for details about the Warranty Period of this product. During the warranty period, and upon proof of purchase, should the product have indications of failure due to faulty workmanship and/or materials, Zyxel will, at its discretion, repair or replace the defective products or components without charge for either parts or labor, and to whatever extent it shall deem necessary to restore the product or components to proper operating condition. Any replacement will consist of a new or re-manufactured functionally equivalent product of equal or higher value, and will be solely at the discretion of Zyxel. This warranty shall not apply if the product has been modified, misused, tampered with, damaged by an act of God, or subjected to abnormal working conditions.

#### Note

Repair or replacement, as provided under this warranty, is the exclusive remedy of the purchaser. This warranty is in lieu of all other warranties, express or implied, including any implied warranty of merchantability or fitness for a particular use or purpose. Zyxel shall in no event be held liable for indirect or consequential damages of any kind to the purchaser.

To obtain the services of this warranty, contact your vendor. You may also refer to the warranty policy for the region in which you bought the device at [http://www.zyxel.com/web/support\\_warranty\\_info.php](http://www.zyxel.com/web/support_warranty_info.php).

### Registration

Register your product online at [www.zyxel.com](http://www.zyxel.com) to receive email notices of firmware upgrades and related information.

### Open Source Licenses

This product may contain in part some free software distributed under GPL license terms and/or GPL like licenses. Open source licenses are provided with the firmware package. You can download the latest firmware at [www.zyxel.com](http://www.zyxel.com). If you cannot find it there, contact your vendor or Zyxel Technical Support at [support@zyxel.com.tw](mailto:support@zyxel.com.tw).

To obtain the source code covered under those Licenses, please contact your vendor or Zyxel Technical Support at [support@zyxel.com](mailto:support@zyxel.com).

# Index

## A

- Access Point [12, 16](#)
- activation
  - SSID [98](#)
- authentication [113, 114](#)
  - RADIUS server [114](#)

## B

- backup
  - configuration [147](#)
- Basic Service Set, see BSS
- BSS [115](#)
  - example [116](#)

## C

- CCMs [150](#)
- certifications [180](#)
  - viewing [183](#)
- CFM [150](#)
  - CCMs [150](#)
  - link trace test [150](#)
  - loopback test [150](#)
  - MA [150](#)
  - MD [150](#)
  - MEP [150](#)
  - MIP [150](#)
- channel
  - WiFi [112](#)
- configuration
  - backup [147](#)
  - reset [148](#)
  - restoring [147](#)
- connection status screen [32](#)
  - overview [83](#)
- Connectivity Check Messages, see CCMs

- contact information
  - customer support [159](#)
- copyright [177](#)
- CTS threshold [113](#)
- customer support [159](#)

## D

- daisy chain [12, 16](#)
- data fragment threshold [113](#)
- disclaimer [177](#)

## E

- encryption [115](#)
- Extended Service Set IDentification [95, 99](#)

## F

- filters
  - MAC address [100, 114](#)
- firmware [143](#)
  - version [86](#)
- fragmentation threshold [113](#)

## G

- guest WiFi settings
  - configuring [88](#)

## I

- icon
  - Language [36](#)



- layout [84](#)
- Logout [36](#)
- Restart [36](#)
- Theme [36](#)

IEEE 802.11ax [93](#)

IGMP

- multicast group list [130](#)

Internet Protocol version 6, see IPv6

IP address [124](#)

- ping [151](#)

IPv6 [165](#)

- addressing [165](#)
- EUI-64 [167](#)
- global address [165](#)
- interface ID [167](#)
- link-local address [165](#)
- Neighbor Discovery Protocol [165](#)
- ping [165](#)
- prefix [165](#)
- prefix length [165](#)
- unspecified address [166](#)

## J

Java permission [30](#)

JavaScript [30](#)

## L

LAN [124](#)

- IP address [124, 125](#)
- status [86, 91](#)
- subnet mask [124, 125](#)

LAN setup [90](#)

Language icon [36](#)

layout icon [91](#)

LBR [150](#)

limitations

- WiFi [115](#)
- WPS [122](#)

link trace [150](#)

Link Trace Message, see LTM

Link Trace Response, see LTR

login [31](#)

- password [31](#)
- Logout icon [36](#)
- logs [127, 130](#)
- Loop Back Response, see LBR
- loopback [150](#)
- LTM [150](#)
- LTR [150](#)

## M

MA [150](#)

MAC address [101](#)

- filter [100, 114](#)

MAC authentication [100](#)

Maintenance Association, see MA

Maintenance Domain, see MD

Maintenance End Point, see MEP

MBSSID [116](#)

MD [150](#)

menu icon [33](#)

MEP [150](#)

MPro Mesh [13](#)

Multiple BSS, see MBSSID

## N

navigation panel [34](#)

network map [34, 84](#)

## P

password [31](#)

PBC [117](#)

- WPS [73](#)

PIN configuration

- WPS [73](#)

PIN, WPS [118](#)

- example [119](#)

preamble [113](#)

preamble mode [116](#)

Push Button Configuration  
  WPS [73](#)  
Push Button Configuration, see PBC  
push button, WPS [117](#)

## R

RADIUS server [114](#)  
Repeater [12, 16](#)  
reset [148](#)  
Reset button [29](#)  
Reset the device [29](#)  
restart [148](#)  
Restart icon [36](#)  
restoring configuration [147](#)  
RFC 3164 [127](#)  
RTS threshold [113](#)

## S

screen order  
  change [84](#)  
screen resolution recommended [30](#)  
security  
  WiFi [113](#)  
service access control [138](#)  
Service Set [95, 99](#)  
SSID [114](#)  
  activation [98](#)  
  MBSSID [116](#)  
status [83](#)  
  firmware version [86](#)  
  LAN [86, 91](#)  
  WiFi [86](#)  
subnet mask [124](#)  
syslog  
  protocol [127](#)  
  severity levels [127](#)  
system  
  firmware [143](#)  
    version [86](#)  
  password [31](#)  
  status [83](#)

  LAN [86, 91](#)  
  WiFi [86](#)  
  time [140](#)  
system information [85](#)

## T

Theme icon [36](#)  
thresholds  
  data fragment [113](#)  
  RTS/CTS [113](#)  
time [140](#)  
TWT (Target Wakeup Time) [93](#)

## U

upgrading firmware [143](#)

## W

warranty [183](#)  
  note [183](#)  
web browser version recommended [30](#)  
Web Configurator  
  layout [33](#)  
  login [31](#)  
  overview [30](#)  
  password [31](#)  
WEP Encryption [97](#)  
WiFi [111](#)  
  authentication [113, 114](#)  
  BSS [115](#)  
    example [116](#)  
  channel [112](#)  
  encryption [115](#)  
  example [111](#)  
  fragmentation threshold [113](#)  
  limitations [115](#)  
  MAC address filter [100, 114](#)  
  MBSSID [116](#)  
  preamble [113](#)  
  RADIUS server [114](#)  
  RTS/CTS threshold [113](#)

- security [113](#)
- SSID [114](#)
  - activation [98](#)
- status [86](#)
- WPS [117](#), [119](#)
  - example [120](#)
  - limitations [122](#)
  - PIN [118](#)
  - push button [117](#)
- WiFi overview [92](#)
- WiFi setting
  - configuration [88](#)
- WiFi6 introduction [93](#)
- wireless basics [92](#)
- wireless channel [156](#)
- wireless LAN [156](#)
- wireless network
  - secure setup [71](#)
- wireless security
  - troubleshooting [156](#)
- wireless tutorial [73](#)
- WPS [28](#), [117](#), [119](#)
  - example [120](#)
  - limitations [122](#)
  - PIN [118](#)
    - example [119](#)
  - push button [117](#)
- WPS button [28](#)
- WPS methods
  - tutorial [73](#)